

Research Article

Techno-Economic Feasibility of Small Scale Hydropower in Ethiopia: The Case of the Kulfo River, in Southern Ethiopia

Zelalem Girma^{1,2}

¹Electrical and Computer Engineering Department, Arba Minch University, P.O. Box 21, Arba Minch, Ethiopia

²University of Kassel, Mönchebergstraße 19, 34109 Kassel, Germany

Correspondence should be addressed to Zelalem Girma; zelalem.girma@amu.edu.et

Received 1 August 2015; Revised 20 October 2015; Accepted 16 November 2015

Academic Editor: Shuhui Li

Copyright © 2016 Zelalem Girma. This is an open access article distributed under the Creative Commons Attribution License, which permits unrestricted use, distribution, and reproduction in any medium, provided the original work is properly cited.

This paper presents the technical and economic feasibility of grid connected small scale hydropower construction in selected site of the Kulfo River in southern Ethiopia. In doing so the paper presents the general overview of Ethiopia electric power situation; small scale hydropower situation and barriers and drivers for its development; site assessment and cost estimation methods and at the end presents techno-economic analysis of small scale hydropower development on the Kulfo River in southern Ethiopia. The technical and economic feasibility of the site have been studied by using HOMER, RETScreen, and SMART Mini-IDRO software. The result of simulation shows that the construction of small scale hydropower in the Kulfo River is technically and economically feasible with total net present cost of \$13,345,150, cost of energy \$0.028/kWh, simple payback period of 12.4 year, and internal rate of return 12.9%. The result also shows that construction of hydropower curtails greenhouse gas emissions such as carbon dioxide by 96,685,45 kg/year, sulfur dioxide by 4,1917 kg/year, and nitrogen dioxide by 20,500 kg/year.

1. Introduction

Ethiopia is located in east Africa with total area of 1.1 million sq. kilometres and a population of more than 90 million and is endowed with enormous renewable energy resources that include 45,000 MW hydropower, 10,000 MW geothermal power, 1,350,000 MW wind, and massive solar and biomass potential [1]. Biomass covers 90% of the total energy consumption, mainly used for cooking in the household. Hydropower contributes significantly to electric generation; the current installed electrical capacity reached 2268 MW and two big hydropower projects with capacity 1870 MW (Gilgel Gibe III) and 6250 MW (Grand Renaissance dam) are under construction. The installed capacity is expected to jump to about 8,000–10,000 MW by the end of the growth and transformation plan (2015) [2].

The country power generation dominated by large hydropower. The mountainous landscape feature coupled with hydrological condition enables the country to generate electricity from hydropower at relatively lower cost when compared to other energy sources. The energy consumption of the country is 45 kWh/capita which is the lowest when

compared to averages of 578 and 2752 kWh/capita for Africa and the world, respectively [3, 4]. The total electric access rate is around 41% and less than 10% of the rural people connected to the national grid. The government has taken different measures to increase electrification access in the country of which formulation of energy policy in 1994 is one of the positive drives [5]. The policy encourages the use of indigenous resources and renewable energy to secure energy supply and reduce use and dependency on fossil fuel. The policy puts hydropower resource development as top priority due to availability of high potential site suitable to generate electricity at relatively lower cost. Furthermore, the revised policy in 1997 and 2013 encourages private independent power producer (IPP) to participate in energy generation by formulating necessary incentives and feed in tariff law [6, 7]. The revised policy also gave due attention for rural electrification by using renewable energy based off-grid technology.

Ethiopian electric power corporation (EPPCO) and Ethiopian rural energy development and promotion centre (EREDPC) are the implementing agencies of grid expansion and off-grid electrification for rural area, respectively, under

Ministry of Water, Irrigation and Energy [8]. EREDPC is mandated for off-grid access expansion by promoting private sector led off-grid rural electrification through participation of the private sector, cooperatives, community based organization, and local government where EEPSCO cannot cover them due to economic terms. According to a 25-year master plan, EEPSCO focused on the development of medium and large hydropower plant [9] even though the country has substantial rivers and streams suitable for small scale hydropower development.

The country generates around 91% of its power from large scale hydropower and small scale hydropower development gets little attention from the government side and contributes a small portion in the energy pool of the country. The total generation potential of hydropower is estimated to be 45 GW of which only 2% is tapped to date [10, 11]. The government five-year (2010–2015) growth and transformation plan mainly focus on the development of large hydropower, whereas small and micro hydropower development have been left to private sector and NGO who are willing to support rural electrification program. As a result the contribution of small and micro hydropower in the energy pool of the country is insignificant. However, there are numerous potential sites identified by the government to generate electric power in small, mini, and micro hydropower capacity. Currently there are few small hydropower plants operational; most of them built by the German Cooperation Organization (GIZ). According to [6], the potential of small and micro hydropower development of the country is estimated from 1500 to 3000 MW or about 10% of the overall hydropower potential. If this potential is exploited and put into operation, it could provide a considerable contribution to the energy mix of the country by meeting the power deficit in the national grid, substituting diesel generators in main and isolated grid and electrifying remote rural area.

In recent times the country has registered remarkable economic performance with average annual growth of 10% over the past 10 years, which is double the sub-Saharan Africa and triple the world average growth over this period [12]. The fast growing economy demands a high energy with annual consumption rate increment of 25%. In recent times, the imbalance between demand and supply of electricity coupled with the inefficiency of electric utility service created huge gap and also negatively affected the economy of the country. The development of small hydropower in potential rivers in the country with low construction and commissioning time will alleviate the power imbalance.

Therefore, this paper examines techno-economic feasibility of small hydropower development on the Kulfo River in the Gamo Gofa zone, near to Arba Minch town in the southern part of Ethiopia to give insight to government, private sector investors, and interested NGO who are willing to contribute to small scale power generation development of the country.

The paper is organized in eight sections. Section 1 is an introduction; Section 2 describes the situation of small scale hydropower development in Ethiopia, its classification, barriers, and drivers; the working principle is described in Section 3; Section 4 discusses site assessment and cost

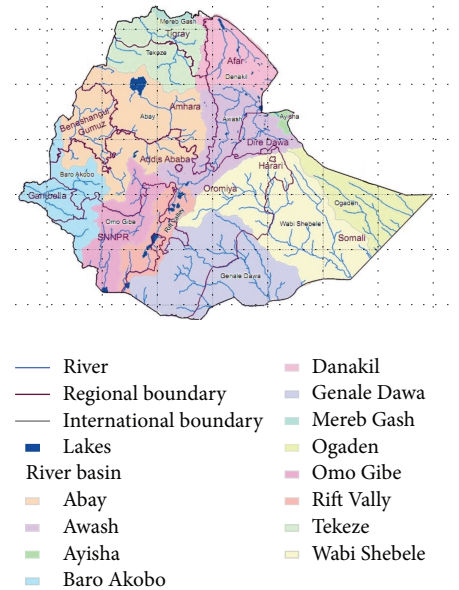

FIGURE 1: Location of major river basin in Ethiopia [15].

estimation method; Section 5 discusses the background of the study site and load profile; Section 6 discusses methodologies; the simulation result will be discussed in Section 7; and conclusion is put in Section 8.

2. Small Scale Hydropower Development in Ethiopia

Small scale hydropower is estimated to be 10% of the total hydropower potential of the country. However, in terms of technical feasibility, the potential could be reduced by more than half to about 5% due to inaccessibility, and proximity to grid and service centres [13]. The available potential of small scale hydropower in the country has hardly been exploited so far due to government focus on large scale hydropower development to meet the energy demand of the country.

As feasibility study, the government identified around 299 hydropower potential sites within eleven river basins with a total potential of 7877 MW including both large and small hydropower. Figure 1 shows major location of river basin in Ethiopia. The Abay river basin is the largest basin in terms of hydropower potential site estimated about 79000 Gwh/yr which cover about 49% of all river basins [14]. The potential for small scale hydropower lies in western and southwestern Ethiopia, where annual rainfall ranges from 300 mm to over 900 mm especially in Omo Gihbe basin and Abay basin.

2.1. Classification of Hydropower Plant. The hydropower plant is classified broadly into different classes based on quantity of water available, available head, and nature of the load [16]. However, classifications vary from country to country as there is currently no internationally agreed standard. Ethiopia uses a classification of hydropower systems which differs from other countries as shown in Table 1.

TABLE 1: Hydropower classification in Ethiopia [17].

Terminology	Capacity	Unit
Large	>30	MW
Medium	10–30	MW
Small	1–10	MW
Mini	501–1000	kW
Micro	11–500	kW
Pico	≤10	kW

In the past majority of small scale hydropower schemes in the country were abandoned due to the encroachment of the national grid with cheaper and more reliable electricity. Currently only one small and two mini hydropower (MHP) schemes are functional under EEPPOs Self-Contained System (SCS), namely, Sor (5 Mw), Yadot (350 kW), and Dembi (800 kW), with a cumulative installed capacity of 6.15 MW. Moreover, another four new small hydropower schemes (Gobecho I = 7 kW, Gobecho II = 30 kW, Hagara Sodicha = 55 kW, and Ererte = 33 kW) have been installed in the southern part of Ethiopia in Sidama zone with the help of the German Cooperation Organization (GIZ) as pilot project in 2011 [17].

To facilitate and support the financing of small scale hydropower scheme the government has also set aside rural energy development and promotion centre under Ministry of Water, Irrigation and Energy, mandated to

- (i) promote small scale hydropower and other renewable energy sources,
- (ii) provide financial support to develop SHP and other renewable energy sources by setting rural electrification fund.

Furthermore, feed in tariffs is under review to encourage private sector participation in power sector development. Therefore, the government incentives, policy, and regulations put SHP business in favourable condition in Ethiopia in recent times.

2.2. Drivers and Barriers of Small Scale Hydropower Development in Ethiopia. There are several pull and push mechanisms set by the government in order to spur the market of SHP despite considerable barriers for market development.

2.2.1. Drivers

- (i) Favourable renewable energy policy: the policy favours the development of electric power from renewable energy sources and established Ethiopian energy agency to be mandated to regulate the electricity market, electricity price regulation, power purchase agreement (PPA), licensing of independent power producer (IPP), and regulating access to the grid by private power producer.
- (ii) Establishment of Ethiopian rural energy development and promotion centre (EREDPC): it is established at

the federal level with a mandate to promote renewable energy technology for rural electrification by setting aside rural energy fund by collecting donation from different organization and government and give soft loans with low interest rate for private power producer.

- (iii) Feed in tariff: the government of Ethiopia announced feed in tariff for powers purchased from IPP for different types of renewable sources which encourages IPPs to enter into power generation business.
- (iv) Introduction of climate resilient green economy strategy (CRGE): Ethiopia initiated and implemented this policy strategy to participate in global climate change mitigation campaign and protect the country from climate change and as a result planned to develop 25 GW of electricity from renewable energy source (22 GW from hydro + 1 GW from geothermal power + 2 GW from wind)

2.2.2. Barriers

- (i) Absence of expertise to fabricate parts, work, and maintain small hydro power plant in the country is one of the barriers.
- (ii) Inaccessibility of small and micro hydro power spare parts in local market is another barrier.
- (iii) Low proposed feed in tariff results in low return on investment for IPP discouraging the private investment.
- (iv) Expansion of irrigation projects in small hydro-streams may prevent hydropower development in downstream.

3. Working Principle of Small Scale Hydropower

The working principle of small hydropower is not different from that of large scale hydropower. It captures the energy of falling water to generate electricity. The water turbine, which is different type depending upon the head and flow rate, converts the energy of falling water into mechanical energy [18]. The electric alternator or generator coupled with turbine converts mechanical energy of rotating shaft into electrical energy according to Faradays' law of electromagnetic induction. The amount of electricity produced mainly depends upon the two factors [19]: a) head: the distance that the water falls; b) flow rate: the volume of water that pass through a given point per second usually measured in meter cube per second. For fixed head the more the water is falling per second on the turbine, the more the power will be produced and vice versa. The flow rate of a given stream may vary seasonally depending upon the location of the site. Different types of water turbine can be used to convert kinetic energy of the flowing water into mechanical energy (rotation of the shaft). The selection of the turbine depends upon head and flow rate as explained in [20, 21]. Furthermore, care has to be taken in terms of constructability, cost, efficiency, maintenance and

serviceability, portability, and scope of modularity during turbine selection.

4. Site Assessment and Cost Estimation

Assessment of the site is a prerequisite in any hydropower development [22–24]. From the result of site assessment one can decide whether the given site is a viable option for hydropower development or not [25]. The key parameters during the assessment are the pressure head, the flow rate of the given river, and wire to water efficiency of the overall system. This parameter can be easily found through measurement and manufacturer specification. Then the power which can be generated at a specific site can be calculated by using the following formula:

$$P = 9.81 \times Q \times H \times \eta, \quad (1)$$

where P is power output in kW, Q is turbine flow in m^3/sec , H is net head in meter (elevation between intake at the river and out late at the turbine less head loss along the power channel), 9.81 is acceleration due to gravity (m/sec^2), and η is overall efficiency of the system.

As seen from the above equation the power generated from the turbine depends upon the discharge rate Q , the net head H , and overall efficiency of the system since other variables are constant in the equation. For the same power output one can either increase head or discharge rate. Usually the head is site-dependent and could not be varied. However, the flow rate can be varied by controlling the water entering into the penstock. However, the turbine should have a capacity to accommodate the increased discharge.

Furthermore, the head, the discharge, and the desired rotational speed of the generator determine the type of turbine to be used. More head or faster flowing water means more power.

Design flow is the maximum flow for which the hydrosystem is designed. It will likely be less than the maximum flow of the stream (especially during the rainy season), more than the minimum flow, and a compromise between potential electrical output and system cost [26]. The flow duration curve (FDC) provides means of selecting the right design discharge by taking into account reserved (residual) flow for environmental and aquatic life purpose. Usually the design flow is assumed to be the difference between the mean annual flow and the residual flow [27]:

$$Q_{\text{design}} = Q_{\text{mean}} - Q_{\text{residual}}. \quad (2)$$

Once the design flow and net head are estimated, suitable head can be selected from turbine selection chart and also note that every turbine has a minimum technical flow under which the turbine cannot operate or has very low efficiency.

In general, planning a hydropower project is a complex and iterative process, where consideration is given to the environmental impact, technological options, economic evaluation, and other constraints. Even though it is difficult to provide a detailed guide on how to evaluate a hydropower scheme, it is possible to provide a short feasibility study of

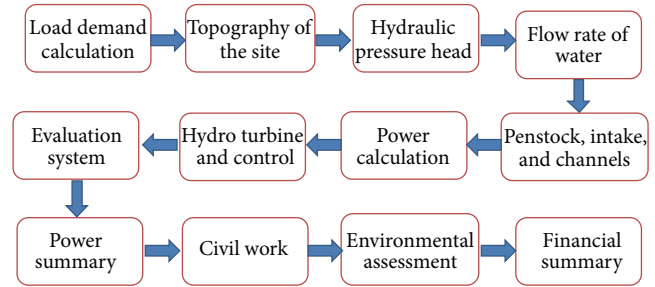

FIGURE 2: Planning and evaluation of a small hydropower plant [30].

a given site configuration in order to develop the project [28, 29]. Figure 2 shows the steps of developing and planning a micro hydropower project [30].

4.1. Cost Estimation. The geographical and geological features along with the effective head, available flow, equipment (turbines, generators, etc.), and civil engineering works determine the capital required for any small hydropower project [31]. In general the cost of hydropower project highly depends upon the site and the location of the project, whether the parts are manufactured locally or imported, and the availability of local skilled manpower to construct and maintain the plant.

Among the many factors that affect the cost of a project are site topography, rock quality, availability of access roads, and the distance to the interconnected grid, earthquake risk, and sediment load in the river [32]. Of course, hydrology and local cost of labor, cement, steel, and explosives also must be factored into the cost equation. In order to grasp the cost structure of hydropower plant around the world and Ethiopia search and review of literatures have been carried out from relevant published papers and reports [33, 34]. Several studies have been carried out to analyze the cost of small hydropower development depending upon the hydraulic characteristics of a given site and a number of cost estimation equations were developed to suite the site specific condition. The researchers on [35–37] developed empirical equations to estimate the cost of hydropower projects based on cost of electromechanical equipment, installed power, hydraulic head, location factors, and so forth. However, developed equations have limitation to apply for all countries in the world since the assumptions used were not inclusive of the nature in all countries. Therefore the World Bank group and IEA [38] studied extensively the project cost of different hydropower projects in the globe and come out with the cost range table depending upon the hydropower type (Table 2) [38].

A recent study of International Renewable Energy Agency (IRENA-2012) [39] also shows that the investment cost of large hydropower plants with storage typically ranges from as low as USD 1050/kW to as high as USD 7650/kW while the range of small hydropower projects is between USD 1300/kW and 8000/kW depending upon the site condition. Figure 3 shows the investment cost in different country, including Ethiopia, and confirms the investment cost report by the Ethiopia's Ministry of Water, Irrigation and Energy which

TABLE 2: World Bank and IEA cost estimate of hydropower [38, 40].

Project cost \$/kW	Head range (m)	Remark
Estimate of World Bank group 2012		
1800–8000	2.3–13.5	Low head
1000–3000	27–350	High head
Estimate of IEA 2010		
2000–7500	Small scale hydropower	
2500–10000	Mini hydropower	
1500–2500	Low head hydropower	

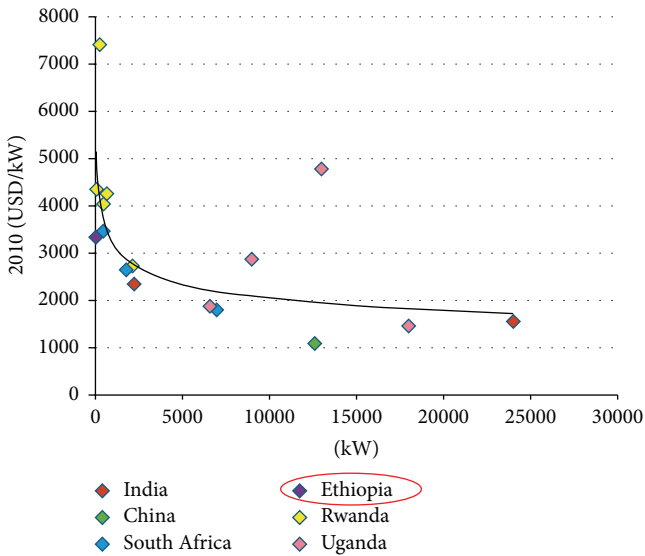

FIGURE 3: Installed capital costs for small hydro in developing countries by capacity [39].

ranges from 3500 to 4000 \$/kW [39]. In the economic assessment of proposed hydropower \$3500/kW was used to estimate the capital cost of the plant.

5. Background of the Study Site

The Kulfo River basin is situated in relatively dry southern area of the Ethiopia in Gamo Gofa zone near to Arba Minch town at latitude 6°N and 37.5°E and is still under geographical modification with hilly topography and impervious soil texture as shown in Figure 4. The river flows through Arba Minch forest and drains into Lake Chamo. The site was selected due to the fact that the river flows throughout the year; it is near to national grid so that it can be easily connected to national grid with low grid interconnection charge; the train of the site is very suitable for hydropower development; and the construction of the power plant does not have social and environmental impact.

As seen from the eleven-year (1994–2007) daily flow data of the river in Figure 5 which was collected from Arba Minch University gauging station, the river has a minimum flow rate of 6 m³/sec. on February and maximum flow of 19.1 m³/sec. on October. Its average flow rate is 12.4 m³/sec. The river has high daily and intermonth variability and low interyear



FIGURE 4: Google satellite map image of the site.

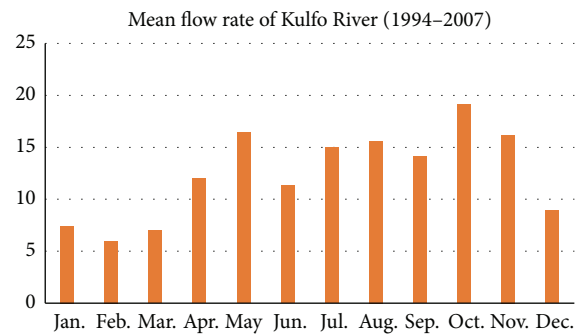

FIGURE 5: Average stream flow of the Kulfo River (1994–2007).

variability. In cases where there were gaps within the data, due to temporary failures of the measuring equipment, the record system, or any other reason, the gaps were noted and the average data of the previous day and the day after the missed data was taken. Furthermore, the data sets were carefully screened for anomalies. Figure 5 shows the monthly flow rate of the Kulfo River.

Prefeasibility study has been done on the site in order to get basic information on the situation of the site, the variability of the river, and the demographic and topographic nature of the site and also to analyze the suitability of the topography for hydropower generation. Form feasibility study it is noted that, in downstream of the river, there is agricultural land owned by private investor which uses part of the river for irrigation. Part of the river is also used by people settled along the water shed of the river. As a result, the location selected for construction of small scale hydropower is above the agricultural land and does not affect the operation of farming in downstream.

As shown in Figure 5 the river has high variability and is not suitable to construct run of river scheme without diversion. The diversion also helps to settle the debris and to control flow of water during rain and dry seasons. Due to hydraulic head limitation and flow constraints the maximum economical potential of the river has calculated as 2.2 MW by taking 50% of available flow rate (9522 L/sec.) at the gross head of 25 meters.

SMART Mini-IDRO software [41, 42] has been used to draw flow duration curve (FDC) and to analyze the preliminary electric generation potential of the river. SMART

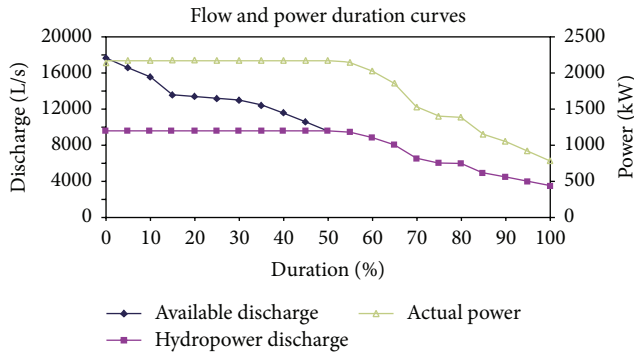

FIGURE 6: FDC and power curve.

Mini-IDRO is a tool for technical and economical evaluation of mini hydropower plants and evaluates the energy production, benefits, and financial aspects and assesses the discharge availability. From the SMART Mini-IDRO software analysis, the river has theoretical potential of 4.5 MW, the technical potential of 4 MW, and economic potential of 2.2 MW. Figure 6 shows FDC and power curve of the site.

6. Methodology

Extensive literature review has been done to grasp the status of electrification and its challenge in the country by giving particular attention on small scale hydropower development to know its past and present status, drivers, barriers, and deployment. The site assessment and cost estimation method in hydropower development have also been reviewed. After getting overall situation on electrification status, small and large scale hydropower development, site assessment, and cost estimation methods, case study site (the Kulfo River) has been selected in southern Ethiopia near Arba Minch town with the following assumptions:

- (i) The developed small hydropower is intended to be owned by the private power producer (IPP).
- (ii) The hydropower first supplies the rural village nearby and supplies surplus power to the national grid at Low voltage.
- (iii) EEPKO is the only buyer of surplus electricity with agreed feed in tariff.
- (iv) Small hydropower station can purchase power from EEPKO during dry season when hydropower fails to supply full load to the rural village.

With the above assumptions techno-economic analysis of the small hydropower constructed on the Kulfo River has been done by using HOMER, RETScreen, and SMART Mini-IDRO software. HOMER is micro power optimization model developed by U.S. National Renewable Energy Laboratory (NREL) to assist the design of micro power system and to facilitate the comparison of different technologies [43, 44]. The software can model off-grid and grid connected power system. It performs three principal tasks: simulation, optimization, and sensitivity analysis. In the simulation process,

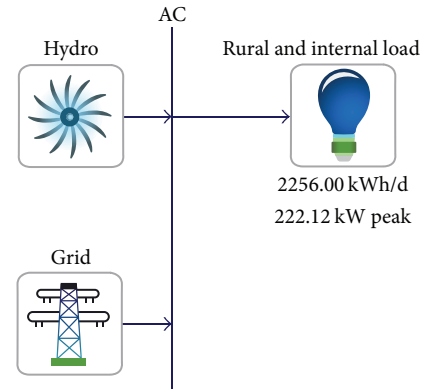

FIGURE 7: HOMER system configuration.

the software models the performance of a micro power system configuration each hour of the year to determine its technical feasibility and life cycle cost. In the optimization process it searches among feasible options the one that satisfies technical constraints at the lowest life cycle cost. In the sensitivity analysis process it assesses the effect of uncertainty or change in the variable over which the designer has no control such as change in flow rate, interest rate, and inflation rate. HOMER uses net present cost (NPC) method to represent the life cycle cost of the system and rank the optimal feasible one according to total net present cost and present the feasible one with lowest total net present cost as the optimal system.

HOMER software has been used to find the optimal total net present cost (TNPC), generation cost of the power plant, to do sensitivity analysis on determinant but uncontrollable variables (flow rate, inflation rate, load change, and grid sale capacity), to compute the total amount electricity purchased from and sold to the grid in kilowatt hour (kWh). RETScreen software has been used to compute simple payback period, internal rate of return and to draw cumulative cash flow within project life time. SMART Mini-IDRO software is used to draw flow duration curve, to determine design flow, and to compute theoretical, technical, and economic potential of proposed hydropower.

7. System Configuration and Simulation Result in HOMER Environment

Figure 7 shows the configuration of the proposed grid connected small scale hydropower with local and internal load in HOMER simulation and optimization environment. The configuration contains hydro, grid, and load as main component.

7.1. Hydro Component. The hydro component in the simulation needs equipment capital cost, replacement cost, maintenance, and operation cost as input variable; the system lifetime for economic evaluation and available head, design flow rate, percentage of minimum and maximum flow rate, efficiency, and pipe friction losses as turbine parameter. After inserting input variables HOMER calculates the electrical

TABLE 3: Turbine and economic input parameter in HOMER software.

Turbine parameter		Description
Available head (m)	25	Net head
Design flow rate (L/sec)	9,522	50% duration
Minimum flow ratio (%)	10	10% of design flow rate which is limited by the turbine to start generation of power
Maximum flow ratio (%)	100	100% design flow
Efficiency (%)	96	Turbine efficiency
Penstock pipe loss	1.4%	
Economic parameter (\$)		Description
Capital cost	7,847,000	\$3500/kW
Replacement cost	7,800,000	Assumed
O&M cost	313,880	4% of capital cost
Lifetime of the project	30 years	Project lifetime

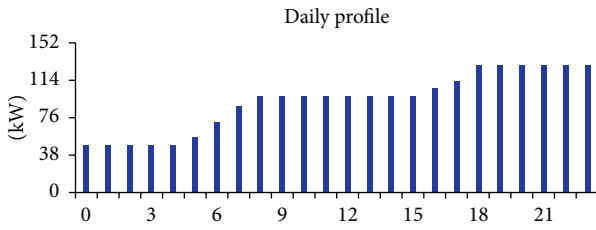

FIGURE 8: Daily load profile of hypothetical village.

power output of the hydro turbine using the following equation:

$$P_{\text{hyd}} = \frac{\eta_{\text{hyd}} \cdot \rho_{\text{water}} \cdot g \cdot h_{\text{net}} \cdot \dot{Q}_{\text{turbine}}}{1000 \text{ W/kW}}. \quad (3)$$

Table 3 shows the input value used in hydro component for proposed hydropower design in HOMER software. The calculated electric power by using (3) is 2,241.86 kW.

7.2. Load Component and Analysis of the Site. For load analysis, hypothetical nearby villages with a peak electrical load of 222 kW, with average energy consumption of the 2256 kWh/day, and with load factor 0.42 were assumed. The assumed load composed of the household appliance, the small enterprise electric machines such as a saw mill, electric welding machine, and other machines used by small enterprises. The daily load profile is as shown in Figure 8.

The consumers grouped into low, medium, and high income class according to yearly income they can generate. The communal services such as school, administrative building, and religious institutions are also considered in load estimation. The assumption was based on the survey made

TABLE 4: Rate schedule (Step 1: define and select a rate).

Rate	Price (\$/kWh)	Sellback (\$/kWh)	Demand (\$/kW/mo)
Rate 1	0.048	0.060	0.000
Rate 2	0.048	0.080	0.000

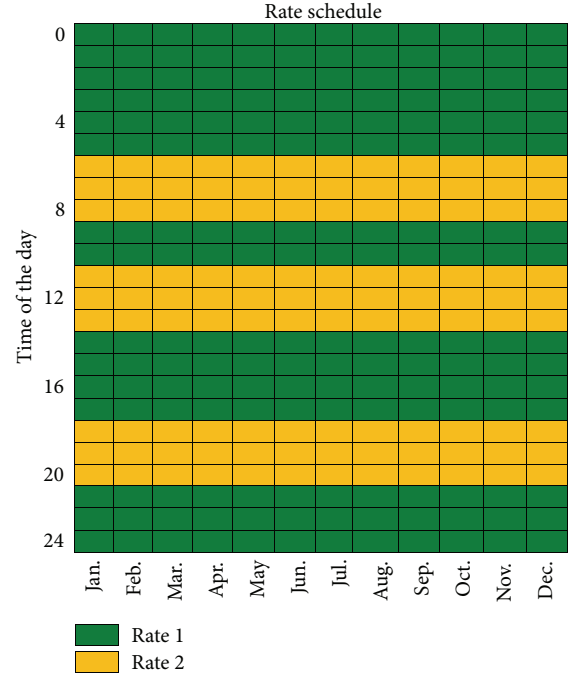

FIGURE 9: Grid sale and purchase rate schedule (see Table 4).

on the grid connected village with the same socioeconomic condition of the hypothetical village.

In order to simulate the load in a more realistic way 10% day-to-day and 20% time-to-time random variable were added in load profile. Furthermore to include future load growth sensitivity analysis has been done on the total load. The result of simulation shows that the proposed hydropower can supply energy of 11,086 kWh without purchasing the power from national grid, above which it starts to purchase power from the grid in order to bridge supply shortage.

7.3. Grid Component. HOMER software has the capacity to simulate grid connected power generation and in doing so it takes as input purchase and sellback rate of electricity. Figure 9 and Table 4 show the rate and grid schedule used in simulation. According to draft feed in tariff document [45], the EEPKO purchases power from IPP with a rate of 0.06 \$/kWh during off-peak period (rate 1) and 0.08 \$/kWh during peak hours (rate 2) for hydropower based generations and sale with rate 0.048 \$/kWh irrespective of peak hours. Furthermore, in the draft feed in tariff proposal the utility requests the IPP to cover grid connection cost and this is assumed to be 4% of the total investment cost in simulation. The maximum power that IPP can purchase from grid is limited to 500 kW and with this scenario IPP can sale up to 2200 kW of the power to the grid after covering the internal

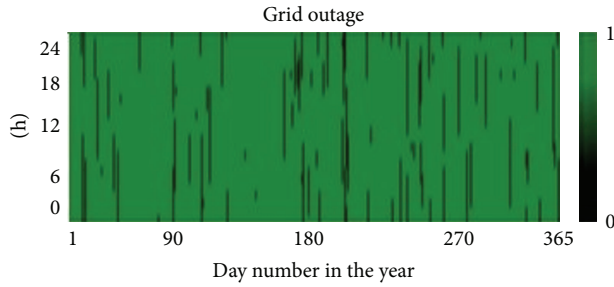

FIGURE 10: Reliability of national grid.

and village load. The simulated rate and schedule are shown in Table 4 and Figure 9.

Since the national grid in Ethiopia is not reliable, grid reliability issue was also included during simulation. The mean failure frequency is taken as 80, repair time variability is taken 90%, and mean repair time was assumed as 5 hours after grid failure. The result of reliability analyses is shown in the following by using random grid outage.

The black lines in Figure 10 show grid outage during which the proposed hydro power could not sell to the grid. Therefore, during this time some way of frequency control needed in power stations.

7.4. Sensitivity Analysis. In order to accommodate the uncertainty of some variables during simulation sensitivity analysis on some essential variables has been done. Sensitivity analysis is used to evaluate the effects of uncertainty on selected input parameters. It is used to quantify the economic consequences of a potential, but uncontrollable changes in important parameters in the future [46, 47]. The sensitivity analysis is very essential during simulation in HOMER software since it gives answers to the designer what if questions. In simulation the following sensitivity variables have been used:

- (i) Total load.
- (ii) The designed flow rate.
- (iii) Inflation.
- (iv) Grid sale capacity.

These variables have the most uncertainty factor in the design. For example, the load may increase in the future as new consumers connected to the local grid and the power consumption of existing user may rise due to usage of electricity for income generation. The flow rate of the river varies throughout the year and accordingly the design flow rate. From flow duration curve it has been seen that there is high flow time and low flow time and two or three turbines may be used to efficiently utilize the available flow.

The inflation is one of the volatile variables in Ethiopia even if the government puts several measures in order to control it. Therefore, this variable has also been used in sensitivity analysis. Figures 11 and 12 show the impact of inflation and the design flow rate on the energy cost of the overall system. Figures 11 and 12 show impact of flow rate and inflation on cost of energy.

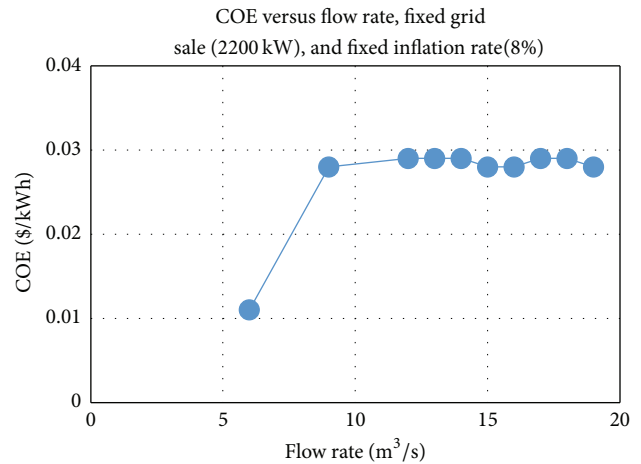

FIGURE 11: Relation between costs of energy versus variation in design flow rate.

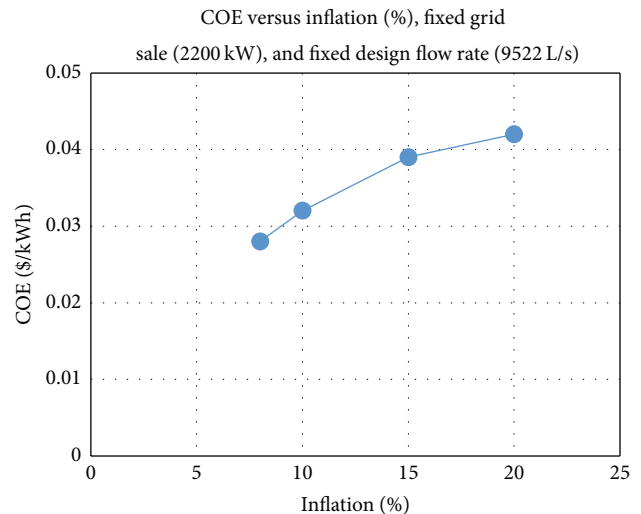

FIGURE 12: Relation between costs of energy versus inflation.

The local load demand as shown in Figure 13 is 818,695 kWh/yr which is 5.1% of the total generation of proposed hydropower (16,116,005 kWh/yr). This indicates that the proposed hydropower can cover the local load without buying the power from the national grid until the local load reaches its production capacity. Even in the worst month, month of February, with a flow rate of 6 m³/sec. and even if this flow rate persists throughout the year the hydropower can generate 11,373,948 kWh/yr and can cover its local load demand.

As shown in Figure 14 the proposed hydropower has significant capacity to sell the surplus electricity to the grid. The lowest energy sold occurred on February which is the dry season and the higher sales occurred on the months of May, July, and August. The highest sale occurs on October. According to simulation the total amount of energy that can be sold to the grid was around 15,298,333 kWh/year.

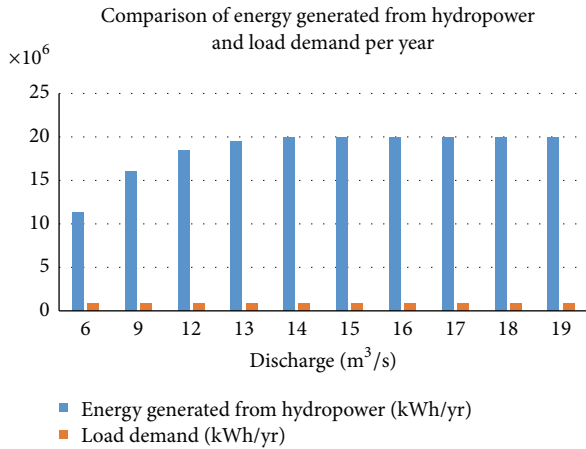

FIGURE 13: Energy generated versus load demand per year.

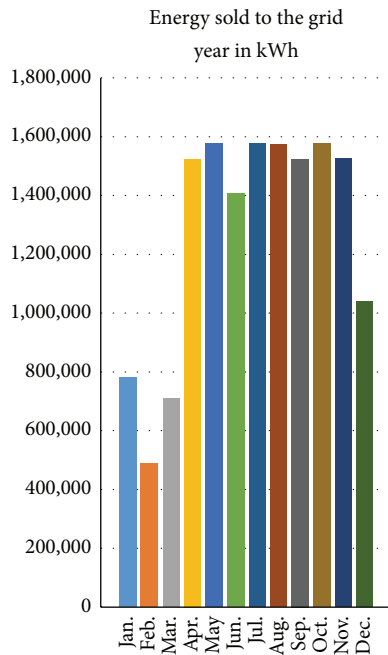

FIGURE 14: Energy sold to the grid in each month of the year.

The total earning from grid sale was around \$1,031,914 per year. Figure 15 shows the monthly income from grid sell. The lowest sell. occurred in the month of February and the highest sale occurs in the month of October.

8. Conclusion

Ethiopia has immense potential for small scale hydropower development. However, to tap these potential active government engagement in facilitating policy and regulatory reform regrading small hydropower is needed. After decades of powers sector reform in the country which allows IPP to produce and sale electricity to national grid, no active participation is seen from private sector. The main bottleneck is the feed in tariff law which is not finalized yet. In addition,

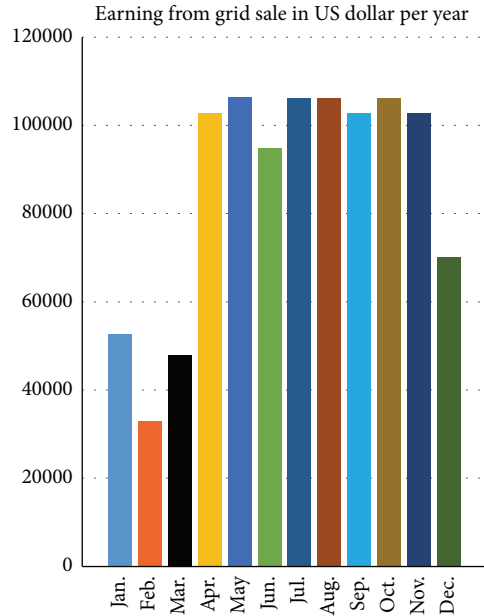

FIGURE 15: Monthly earning from grid sale.

Financial viability		
Pretax IRR-equity	(%)	12.9%
Pretax IRR-assets	(%)	4.9%
Simple payback	(yr)	12.4%
Equity payback	(yr)	13.4%

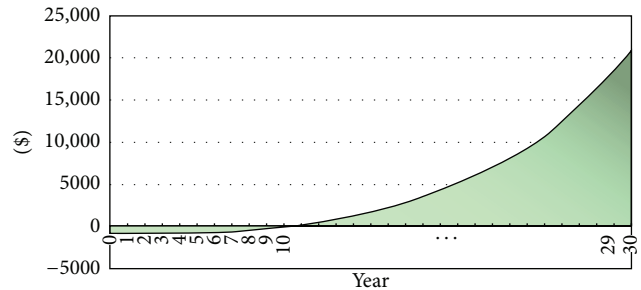

FIGURE 16: Cumulative cash flow of the project with RETScreen simulation software.

TABLE 5: System architecture.

Hydro	Hydroelectric	2,242	kW
Grid	Grid	500	kW
Dispatch strategy	Load following		

TABLE 6: Cost summary.

Total net present cost	-13345150	\$
Levelized cost of energy	-0.028	\$/kWh

government has to use various push and pull mechanisms to promote and motivate IPP in power generation market. Moreover the required data regarding small hydropower

TABLE 7: Net present costs.

Component	Capital	Replacement	O&M	Fuel	Salvage	Total
Hydro	7,847,000	0	9,416,400	0	0	17,263,400
Grid	313,880	0	-30,957,424	0	0	-30,643,544
Other	5,000	0	30,000	0	0	35,000
System	8,165,880	0	-21,511,026	0	0	-13,345,146

TABLE 8: Annualized costs.

Component	Capital	Replacement	O&M	Fuel	Salvage	Total
Hydro	261,567	0	313,880	0	0	575,447
Grid	10,463	0	-1,031,914	0	0	-1,021,451
Other	167	0	1,000	0	0	1,167
System	272,196	0	-717,034	0	0	-444,838

System architecture:			Total NPC	
Grid (500 kW)			(3,345,150)	
Hydroelectric (2241.9 kW)			Levelized COE: (\$0.028)	
Load following			Operating cost: (\$717,034)	

Production (kWh/yr)	(%)
Hydro	16,116,005 100
Total	16,116,005 100

Consumption (kWh/yr)	(%)
AC primary load	818,695 5.1
DC primary load	0 0.0
Grid sales	15,298,330 94.9
Total	16,117,025 100.0

Quantity	(kWh/yr)	(%)
Excess electricity	8.7	0.0
Unmet electric load	0.0	0.0
Capacity shortage	0.0	0.0

Quantity	Value
Renewable fraction	100.0
Max. renew. penetration	100.4

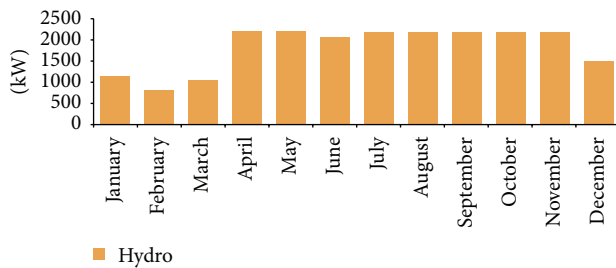

FIGURE 17: Electrical output.

System architecture:			Total NPC	
Grid (500 kW)			(3,345,150)	
Hydroelectric (2241.9 kW)			Levelized COE: (\$0.028)	
Load following			Operating cost: (\$717,034)	

Quantity	Value	Units
Nominal capacity	2241.9	(kW)
Mean output	1839.7	(kW)
Capacity factor	82.063	(%)
Total production	16116005	(kWh/yr)

Quantity	Value	Units
Minimum output	817.57	(kW)
Maximum output	2210.5	(kW)
Hydro penetration	1968.5	(%)
Hours of operation	8760	(hrs/yr)
Levelized cost	0.035707	(\$/kWh)

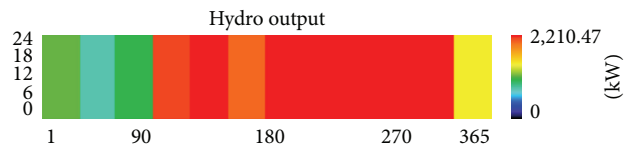

FIGURE 18: Hydroelectric output.

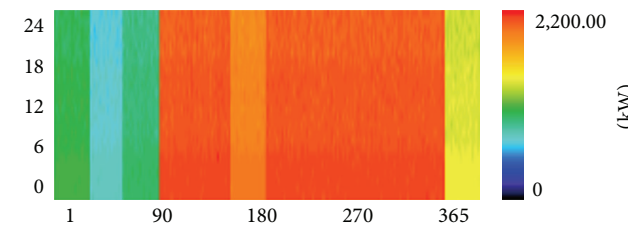

FIGURE 19: Energy sold to grid.

development has to be gathered and put into database so that interested IPP can access and do informed decisions.

In this work overall electrification status in Ethiopia and small scale hydropower development situation with its drivers and barriers have been reviewed in the first few sections. The policy and regulatory changes in powers sector reform have also been dealt. Then techno-economic feasibility study on selected site in southern region on the Kulfo River has been done in order to assess and study technical and economic feasibility of the project. Techno-economic analysis has been done by using HOMER and RETscreen software has been used to calculate payback period and IRR and also used to draw cumulative cash flow (Figure 16). Overall potential (theoretical, technical, and economic) of

proposed hydropower has been computed by using SMART Mini-IDRO software. The objective is to show the overall situation of small hydropower and its technical and economic feasibility by using simulation.

The result of HOMER simulation software shows that small hydropower development is profitable in the proposed specific site. It has very low levelized cost of energy (COE) around \$0.028/kWh for proposed local load. It has also least total net present cost of \$13,345,150 and can deliver 95% of the generated power to the grid after covering the local load. It is also seen from the result of RETscreen software that the project has simple payback time of 12.4 years with IRR of

TABLE 9: Electrical.

Quantity	Value	Units
Excess electricity	9	kWh/yr
Unmet load	0	kWh/yr
Capacity shortage	0	kWh/yr
Component	Production (kWh/yr)	Fraction (%)
Total	16,116,005	100
Load	Consumption (kWh/yr)	Fraction (%)
AC primary load	818,695	5
DC primary load	0	0
Grid sales	15,298,330	95
Total	16,117,025	100

TABLE 10: Emissions.

Pollutant	Emissions	Units
Carbon dioxide	-9668545	kg/yr
Carbon monoxide	0	kg/yr
Unburned hydrocarbons	0	kg/yr
Particulate matter	0	kg/yr
Sulfur dioxide	-41917	kg/yr
Nitrogen oxides	-20500	kg/yr

12.9%. As shown in the simulation of this particular site, small scale hydropower is a technical and economical feasibility in this specific selected site.

Appendix

Sample HOMER Simulation Output

System Report. See Tables 5, 6, 7, 8, 9, and 10 and Figures 17, 18, and 19.

Conflict of Interests

The author declares that there is no conflict of interests regarding the publication of this paper.

References

- [1] D. Derbew, "Ethiopia's Renewable Energy Power Potential and Development Opportunities," 2013, http://www.irena.org/DocumentDownloads/events/2013/July/Africa%20CEC%20session%203_Ministry%20of%20Water%20and%20Energy%20-Ethiopia_Beyene_220613.pdf.
- [2] Ethiopian Energy Authority, June 2015, <http://www.ethioenergyauthority.gov.et/attachments/article/63/DRAFT%20FINAL-%20MARCH%206%202015%20%20Version%20IIIcomment.pdf>.
- [3] D. Chandrasekharam and V. Chandrasekhar, "Clean development mechanism through geothermal: Ethiopian scenario," in *Proceedings of the 4th African Rift Geothermal Conference*, Nairobi, Kenya, November 2012.
- [4] A. Evans, *Resources, Risk and Resilience: Scarcity and Climate Change in Ethiopia*, Center on International Cooperation, New York University, 2012, http://cic.nyu.edu/sites/default/files/evans_security.ethiopia.2012.pdf.
- [5] Small scale Hydro power for rural development, Nile basin capacity building network NBCBN, 2005, http://www.nbcbn.com/Project_Documents/Progress_Reports/Hp-G1.pdf.
- [6] M. Abebe, "The Ethiopian power sector reform and its role for enhancing IPP investment opportunities," April 2015, <http://www.engerati.com/hubs/articles/ethiopian-power-sector-reform-and-its-role-enhancing-ipp-investment-opportunities>.
- [7] M. Teferra, "Power sector reforms in Ethiopia: options for promoting local investments in rural electrification," *Energy Policy*, vol. 30, no. 11-12, pp. 967-975, 2002.
- [8] USAID, "Investment Brief for energy sector in Ethiopia," <http://www.usaid.gov/powerafrica>.
- [9] Ethiopian Power System Expansion Master Plan update (EPSEMPU), <http://www.bgr.de/geotherm/ArGeoCI/pdf/06%20Energy%20master%20plan.pdf>.
- [10] M. Abebe, "Hydropower development in Ethiopia vis-a-vis perspective regional power trade," in *Proceedings of the International Information System for the Agricultural Science and Technology (AGRIS '05)*, pp. 155-180, 2005.
- [11] Ethiopia Energy Situation, https://energypedia.info/wiki/Ethiopia_Energy_Situation#Hydropower.
- [12] Country Economic Brief—UNDP in Ethiopia, <http://www.et.undp.org/content/dam/ethiopia/docs/Country%20Economic%20Brief%201%20final%20for%20web.pdf>.
- [13] Shanko, Melessaw Target Market Analysis: Ethiopia's Small Hydro Energy Market, https://www.giz.de/static/themen_umleitung/index.html.
- [14] W. Abteu and A. M. Melesse, "Enhancing water productivity in crop-livestock systems of the Nile Basin: improving systems and livelihoods," in *Proceedings of the Workshop on Hydrology and Ecology of the Nile River Basin under Extreme Conditions*, pp. 16-19, Aardvark Global, Addis Ababa, Ethiopia, June 2008.
- [15] Major River Basins of Ethiopia, February 2015, <http://www.idp-uk.org/Resources/Maps/TopographicThematic%20Maps/Major-River-Basins-Map.pdf>.
- [16] W. J. Klunne, "Small hydropower in Southern Africa—an overview of five countries in the region," *Journal of Energy in Southern Africa*, vol. 24, no. 3, pp. 14-25, 2013.
- [17] K. Meder, *Application of environment assessment related to GIZ ECO micro hydropower plants in the Sidama Zone/Ethiopia [M.S. thesis]*, Heidelberg University, Heidelberg, Germany, 2011.
- [18] O. Paish, "Small hydro power: technology and current status," *Renewable and Sustainable Energy Reviews*, vol. 6, no. 6, pp. 537-556, 2002.
- [19] A. Omojola and O. A. Oladejib, "Small hydro power for rural electrification in Nigeria," *American Journal of Science and Engineering*, vol. 1, no. 2, 2012.
- [20] M. Saikia, "Remote village electrification by small hydropower project in Assam," *Indian Journal of Energy*, vol. 3, no. 1, pp. 140-147, 2014.
- [21] H. Sharma and J. Singh, "Run off river plant: status and prospects," *International Journal of Innovative Technology and Exploring Engineering*, vol. 3, no. 2, pp. 210-213, 2013.
- [22] B. C. Kusre, D. C. Baruah, P. K. Bordoloi, and S. C. Patra, "Assessment of hydropower potential using GIS and hydrological modeling technique in Kopili River basin in Assam (India)," *Applied Energy*, vol. 87, no. 1, pp. 298-309, 2010.
- [23] C.-S. Yi, J.-H. Lee, and M.-P. Shim, "Site location analysis for small hydropower using geo-spatial information system," *Renewable Energy*, vol. 35, no. 4, pp. 852-861, 2010.

- [24] L. Kosnik, "The potential for small scale hydropower development in the US," *Energy Policy*, vol. 38, no. 10, pp. 5512–5519, 2010.
- [25] C. S. Kaunda, C. Z. Kimambo, and T. K. Nielsen, "Potential of small-scale hydropower for electricity generation in Sub-Saharan Africa," *ISRN Renewable Energy*, vol. 2012, Article ID 132606, 15 pages, 2012.
- [26] BHA, *A Guide to UK Mini-Hydro Developments*, BHA, 2005, http://www.british-hydro.org/Useful_Information/A%20Guide-%20to%20UK%20mini-hydro%20development%20v3.pdf.
- [27] <http://www.microhydropower.net/>.
- [28] U. G. Wali, "Estimating hydropower potential of an ungauged stream," *International Journal of Emerging Technology and Advanced Engineering*, vol. 3, no. 11, pp. 592–600, 2013.
- [29] M. C. Tuna, "Feasibility assessment of hydroelectric power plant in ungauged river basin: a case study," *Arabian Journal for Science and Engineering*, vol. 38, no. 6, pp. 1359–1367, 2013.
- [30] Small Hydro power, 2015, <http://smallhydro.com>.
- [31] S. K. Singal, R. P. Saini, and C. S. Raghuvanshi, "Analysis for cost estimation of low head run-of-river small hydropower schemes," *Energy for Sustainable Development*, vol. 14, no. 2, pp. 117–126, 2010.
- [32] A. Date and A. Akbarzadeh, "Design and cost analysis of low head simple reaction hydro turbine for remote area power supply," *Renewable Energy*, vol. 34, no. 2, pp. 409–415, 2009.
- [33] H. Motwani, S. V. Jain, R. N. Patel et al., "Cost analysis of pump as turbine for pico hydropower plants—a case study," *Procedia Engineering*, vol. 51, pp. 721–726, 2013.
- [34] S. Mishra, S. K. Singal, and D. K. Khatod, "Costing of a small hydropower projects," *International Journal of Engineering and Technology*, vol. 4, no. 3, pp. 239–242, 2012.
- [35] J. L. Gordon and A. C. Penman, "Quick estimating techniques for small hydro potential," *Journal of Water Power and Dam Construction*, vol. 31, pp. 46–55, 1979.
- [36] D. Papantonis, *Small Hydro Power Stations*, Simeon, Athens, Greece, 2001.
- [37] G. A. Aggidis, E. Luchinskaya, R. Rothschild, and D. C. Howard, "The costs of small-scale hydro power production: impact on the development of existing potential," *Renewable Energy*, vol. 35, no. 12, pp. 2632–2638, 2010.
- [38] Q. F. (Katherine) Zhang, "Small Hydropower Cost Reference Model," May 2015, <http://info.ornl.gov/sites/publications/files/pub39663.pdf>.
- [39] IRENA, *Renewable Energy Technologies: Cost Analysis Series, Hydropower, Volume 1: Power Sector Issue 3/5*, International Renewable Energy Agency, Masdar City, United Arab Emirates, 2012.
- [40] IEA-ETSAP, "Technology Brief E12," 2010, <http://www.etsap.org/>.
- [41] SEE hydropower clean water clean energy, http://www.seehydropower.eu/download_tools/details.php?id=1.
- [42] Technical/economical evaluation of SHP plants: SMART Mini-Idro tool, April 2015, <http://www.seehydropower.eu/>.
- [43] RETScreen, <http://www.retscreen.net/>.
- [44] HOMERsoftware, <http://homerenergy.com/software.html>.
- [45] J. Nganga, M. Wohlert, and M. Woods, *Powering Africa through Feed-in Tariffs*, Renewable Energy Ventures Kenya, Nairobi, Kenya, 2013, <https://www.boell.de/sites/default/files/2013-03-powering-africa-through-feed-in-tariffs.pdf>.
- [46] J. K. Kaldellis, D. S. Vlachou, and G. Korbakis, "Techno-economic evaluation of small hydro power plants in Greece: a complete sensitivity analysis," *Energy Policy*, vol. 33, no. 15, pp. 1969–1985, 2005.
- [47] A. Salmani, S. Sadeghzadeh, and M. R. Naseh, "Optimization and sensitivity analysis of a hybrid system in KISH-IRAN," *International Journal of Emerging Technology and Advanced Engineering*, vol. 4, no. 1, 2014.

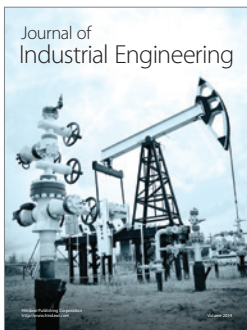
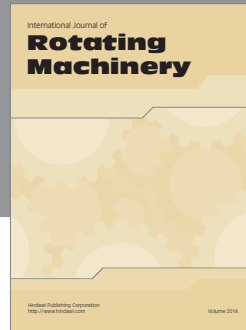
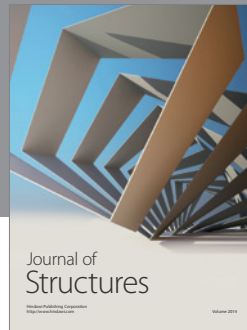
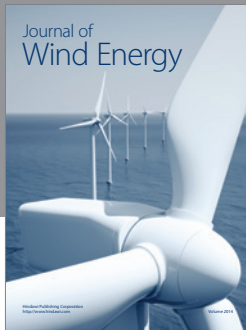

Hindawi

Submit your manuscripts at
<http://www.hindawi.com>

