

LPS and MTP-PE (liposome-encapsulated *N*-acetyl-muramyl-L-alanyl-D-isoglutaminyl-L-alanine-2-:[1',2'-dipalmitoyl-*sn*-glycero-3-(hydroxy-phosphoryl-oxyl)] ethylamide) induce in liver macrophages a synthesis and release of TNF- $\alpha$ , nitric oxide and prostanoids. Both agents induce an expression of mRNA's encoding TNF- $\alpha$ , inducible nitric oxide synthase (iNOS) and cyclooxygenase (COX)-2, and of corresponding proteins. LPS and MTP-PE induce a rapid activation of the extracellular regulated kinase (ERK) isoenzymes-1 and -2. Inhibition of map kinase isoenzymes leads to a decreased release of TNF- $\alpha$ , nitric oxide and prostaglandin (PG) E<sub>2</sub> after both agents. The transcription factors NF- $\kappa$ B and AP-1 are strongly activated by LPS within 30 minutes. MTP-PE induces a weak activation of both transcription factors only after 5 hours. Inhibition of NF- $\kappa$ B inhibits the LPS- but not the MTP-PE-induced release of TNF- $\alpha$ , nitric oxide and PGE<sub>2</sub>. PGE<sub>2</sub> release after LPS is higher than after MTP-PE. Exogenously added PGE<sub>2</sub> inhibits the activation of map kinase and TNF- $\alpha$  release by LPS, but not by MTP-PE. Release of nitric oxide after LPS and MTP-PE is enhanced after prior addition of PGE<sub>2</sub>. PGE<sub>2</sub> is without any effect. MTP-PE, but not LPS, induces a cytotoxicity of Kupffer cells against P815 tumor target cells. The MTP-PE-induced cytotoxicity is reduced by TNF- $\alpha$  neutralizing antibodies, indicating the involvement of TNF- $\alpha$ . Thus our results suggest that the different potencies of LPS and MTP-PE as immunomodulators probably result from different actions on Kupffer cells, resulting in differences in the amounts and kinetics of released TNF- $\alpha$  and PGE<sub>2</sub>, and that PGE<sub>2</sub> plays an important regulatory role in the action of LPS, but not in the actions of MTP-PE.

**Key words:** LPS, Macrophages, Muramyl tripeptides, Cytokines, Eicosanoids

## Prostaglandin E2 affects differently the release of inflammatory mediators from resident macrophages by LPS and muramyl tripeptides

Peter Dieter<sup>1,CA</sup>, Ute Hempel<sup>1</sup>, Sabine Kamionka<sup>1</sup>, Angelika Kolada<sup>1</sup>, Birgit Malessa<sup>1</sup>, Edith Fitzke<sup>2</sup> and Thuy-Anh Tran-Thi<sup>2</sup>

<sup>1</sup>Institute of Physiological Chemistry, Medical Faculty, Dresden University of Technology, Dresden, Germany; <sup>2</sup>Institute of Biochemistry and Molecular Biology, Albert-Ludwigs-University, Freiburg, Germany

<sup>CA</sup>Corresponding Author

Institute of Physiological Chemistry, Medical Faculty, Dresden University of Technology, Karl-Marx-Strasse 3, D-01109 Dresden, Germany  
Tel: (351) 8832 851  
Fax: (351) 8832 869  
Email: dieter@rcs.urz.tu-dresden.de

## Introduction

Liver macrophages (Kupffer cells) are macrophages residing in the sinusoids of the liver. This strategic location makes them the first macrophages to come into contact with noxious materials that enter circulation via the portal vein. This location and the fact that they constitute the largest pool of macrophages in the body attributes to them an important function in the clearance of noxious material, the removal of migrating tumor cells, and in the pathophysiology of septic shock.<sup>1</sup>

Liver macrophages have been reported to secrete a wide array of biologically active compounds including cytokines, prostanoids, nitric oxide and oxygen radicals, which have been shown to be involved in the pathogenesis of septic shock, and in the cytotoxicity of Kupffer cells against tumor target cells.<sup>1–7</sup>

LPS and muramyl tripeptides are components of the outer cell membrane of most bacteria and display most

of the immunological activities compared with an infection of whole bacteria.<sup>8–11</sup> When administered i.v., LPS and liposome-encapsulated *N*-acetyl-muramyl-L-alanyl-D-isoglutaminyl-L-alanine-2-[1', 2'-dipalmitoyl-*sn*-glycero-3'-(hydroxy-phosphoryl-oxyl)] ethylamide (MTP-PE)<sup>3</sup> are delivered predominantly to macrophages, especially liver macrophages.<sup>12,13</sup> While LPS has been shown to play a significant role in the pathogenesis of gram-negative septic shock, muramyl tripeptides have been demonstrated to be protective against LPS-induced septicemia.<sup>14,15</sup> Furthermore, i.v. administered MTP-PE has been shown to induce antitumor reactivity, probably as a result of macrophage activation,<sup>16–19</sup> and to inhibit HIV replication in macrophages.<sup>20</sup>

In contrast to LPS, very little is known about the intracellular signal transduction pathways of muramyl tripeptides. Recently, we showed that MTP-PE and LPS induce similar reactions in liver macrophages, like the formation of TNF- $\alpha$ , nitric oxide and prostanoids.<sup>21</sup>

Furthermore, we demonstrated, that cellular calcium and protein kinase C isoenzymes are not involved in the signal pathways of LPS and MTP-PE.<sup>21</sup>

## Materials and methods

### Materials

Medium RPMI 1640, newborn and fetal calf serum are purchased from Biochrom (Berlin, Germany); newborn calf serum is heat-inactivated at 56°C for 30 min [ $\gamma$ -<sup>32</sup>ATP] and [<sup>3</sup>H]thymidine are from Amersham Buchler (Braunschweig, Germany). P815 mouse mastocytoma and mouse L929 cells are purchased from American Type Culture Collection (Rockville, USA). Murine rTNF- $\alpha$  and rat TNF- $\alpha$ -neutralizing antibodies are from Boehringer Mannheim (Mannheim, Germany) and IC Chemikalien (Ismaning, Germany), respectively. BAY 11-7082 and PD 98059 are purchased from Calbiochem (Bad Soden, Germany). Monoclonal antibodies against COX-2 and iNOS are purchased from Natutuec (Frankfurt, Germany) and Transduction Laboratories/Dianova (Hamburg, Germany), respectively. MTP-PE is kindly provided by Ciba-Geigy (Basel, Switzerland). LPS R595 from *Salmonella minnesota* is a gift from Dr Galanos (Freiburg, Germany). Antibodies raised against prostaglandin (PG) E<sub>2</sub> and PGD<sub>2</sub> are generous gifts from Dr Brune (Erlangen, Germany) and Dr Hayaishi (Osaka, Japan), respectively. RT-PCR reagents and enzymes are from Perkin Elmer (Weiterstadt, Germany). Specific primers (HPLC purified) are synthesized and purchased from Birsner & Grob (Denzlingen, Germany).

### Cell culture

Livers of male Wistar rats (Charles River, Sulzfeld, Germany) are removed aseptically under Nembutal anaesthesia, and the liver macrophages are isolated by a centrifugal elutriation procedure.<sup>22</sup> Liver macrophages are maintained in primary culture with RPMI 1640 medium containing 30% newborn calf serum. All experiments are performed with cells kept in primary culture for 48–72 h. P815 mouse mastocytoma cells and L929 cells are grown in RPMI 1640 medium containing 10% FCS.

### Determination of PGE<sub>2</sub> and PGD<sub>2</sub>

Macrophages are incubated in RPMI medium containing 10% newborn calf serum with or without LPS or MTP-PE, and after the indicated times cell media are removed and centrifuged. The amount of PGE<sub>2</sub> and PGD<sub>2</sub> in cell media is measured by ELISA and RIA, respectively, as described elsewhere.<sup>23</sup>

### Determination of TNF- $\alpha$ activity

The release of TNF- $\alpha$  activity is measured using the L929 cell cytotoxicity assay in which lysis of actinomycin-D-treated L929 cells by TNF- $\alpha$  is measured by crystal violet staining of survival cells in monolayer culture.<sup>24</sup> L929 cells are grown on 96-well microtest plates to the density of  $\sim 4 \times 10^4$  cells/well. Culture media to be tested are added to the wells together with actinomycin (400 ng/well). After 24 h, the supernatants are discharged and the remaining cells are stained with 0.5% crystal violet in 25% aqueous methanol for 10 min. The dye is removed by washing three times with 25% methanol, and 5% SDS is added to solubilize the adherent cells. Then the absorbance is read with a microplate reader (Titertek Multiskan Plus) at 550 nm. The absorbance is compared with that of a standard solution of murine rTNF- $\alpha$ . Units of TNF- $\alpha$  activity are the reciprocal dilution factor of a sample causing 50% lysis of L929 cells. The specificity is controlled by neutralization with rat TNF- $\alpha$ -neutralizing antibodies (dilution of 1:50).

### Determination of nitric oxide

Macrophages are incubated in RPMI medium containing 10% newborn calf serum with or without LPS or MTP-PE, and after the indicated times cell media are removed and centrifuged. Nitric oxide formation is measured as NO<sub>2</sub><sup>-</sup> accumulated in the cell media, which reflects the release of nitric oxide from macrophages.<sup>3</sup> The Griess reaction using 20  $\mu$ l of sulfanilamide (10 mM), 10  $\mu$ l of HCl (2 M), 10  $\mu$ l of naphthylethylenediamine dihydrochloride (1 mM), and 150  $\mu$ l of supernatant is applied to each well of a microtiter plate; the pink azo dye is quantitated by a microplate reader (Titertek Multiskan Plus) at 550 nm. Standards are prepared using NaNO<sub>2</sub><sup>-</sup>.

### In vitro cytotoxicity assay

Macrophages are cultured on 96-well plates at a density of  $\sim 10^5$  cells/well. P815 target cells in the exponential growth phase are radiolabeled by a 24 h-incubation in RPMI medium with 10% FCS containing 20  $\mu$ Ci of [<sup>3</sup>H]thymidine/10<sup>6</sup> cells in 5 ml. Then the cells are washed three times to remove the radioisotope and resuspended in culture medium to a concentration of 10<sup>5</sup> cells/ml. 100  $\mu$ l (10<sup>4</sup> [<sup>3</sup>H]thymidine-labeled target cells) is added to cultured macrophages in a total volume of 200  $\mu$ l of medium/well. LPS or MTP-PE is added to macrophages 6 h before the addition of target cells. Radiolabeled target cells are also plated alone as an additional control. 48 h after the addition of target cells, the supernatants are collected and the radioactivity is measured in a liquid scintillation counter. Cytolysis is calculated as follows: % cytolysis =  $100 \times (a-b)/(c-b)$ , where  $a$  = cpm in

supernatants of target cells cocultured with macrophages,  $b$ =cpm in supernatants of target cells cultured alone,  $c$ =cpm in the total amount of target cells added per well.

### Western blot analysis

Total protein (10  $\mu$ g) is separated on 10% polyacrylamide gels under reducing conditions. Proteins are transferred to nitrocellulose membranes, and nonspecific binding is blocked by incubation in PBS containing 0.1% Tween 20 and 5% milk powder. The plots are probed with antibodies against COX-2 and iNOS. After extensive washing, the blots are incubated with the secondary antibodies, washed extensively and developed using the ECL Western blotting detection system (Amersham). For quantitative analysis, the bands are scanned densitometrically.

### In situ map-kinase assay

Map kinase activity is performed by an *in vitro* renaturation assay.<sup>25,26</sup> Cells are washed with PBS and lysed in 50 mM Tris-HCl, pH 7.5, 150 mM NaCl, 1% (w/v) Triton X-100, 0.1 mM  $\text{Na}_3\text{VO}_4$ , 1 mM phenylmethylsulfonyl fluoride, 0.1 mM aprotinin, vortexed and centrifuged at 15000 $\times g$  for 30 min. The supernatants are matched for protein content (BioRad protein dye assay) and diluted to 1 mg/ml protein in 62.5 mM Tris-HCl, pH 6.8, containing 2.3% (w/v) SDS, 5 mM EDTA, 10% (v/v) glycerol and 100 mM DTT and heated at 86°C for 5 min before SDS-PAGE. The gels are polymerized with 0.2 mg/ml myelin basic protein and, after electrophoresis, denatured in 6 M guanidine hydrochloride. After renaturation, the gels are preincubated in 25 mM HEPES, pH 7.4, 2 mM 2-mercaptoethanol, 10 mM  $\text{MgCl}_2$ , 0.1 mM  $\text{Na}_3\text{VO}_4$  and 0.5 mM EGTA at 30°C for 30 min. The kinase reaction is performed by incubation of the gels in 25 mM HEPES, pH 7.4, 2 mM 2-mercaptoethanol, 10 mM  $\text{MgCl}_2$ , 0.1 mM  $\text{Na}_3\text{VO}_4$ , 0.5  $\mu$ M EGTA, 25  $\mu$ M ATP and 250  $\mu$ Ci [ $\gamma$ -<sup>32</sup>P]ATP.

### Electrophoretic mobility shift assay

Determination of the DNA-binding capacity of NF- $\kappa$ B and AP-1 is performed exactly as described previously.<sup>27</sup>

### RT-PCR studies

RNA from macrophages is prepared according to Chomzynski and Sacchi.<sup>28</sup> In brief, 1–2 $\times 10^6$  macrophages are frozen in liquid nitrogen, taken up in guanidinium thiocyanate and extracted with acidified phenol/chloroform. After centrifugation, RNA is precipitated from the aqueous phase with isopropanol. The pellet is washed once with 80% ethanol and then taken up in 10  $\mu$ l  $\text{H}_2\text{O}$ . The total amount of RNA is determined spectrophotometrically and reverse

transcribed (22°C/10 min–42°C/60 min–95°C/5 min/4°C, Perkin Elmer PCR System 2400) using recombinant moloney murine leukemia virus reverse transcriptase (2.5 units/ $\mu$ l) in 500 mM KCl, 100 mM Tris-HCl, pH 8.3, 5  $\mu$ M  $\text{MgCl}_2$ , 2.5  $\mu$ M random hexamers, 1 unit/ $\mu$ l RNase inhibitor, 2.5  $\mu$ M of each dATP, dCTP, dGTP, dTTP and approximately 0.5 mg RNA in a total volume of 10  $\mu$ l. For PCR analysis, a master mix is prepared containing buffer (500 mM KCl, 100 mM Tris-HCl, pH 8.3),  $\text{MgCl}_2$  (final concentration 1 mM) and AmpliTaq DNA Polymerase (final concentration 1.25 units/50  $\mu$ l). For single PCR analysis, 35  $\mu$ l of master mix solution, 5  $\mu$ l of specific primers and 10  $\mu$ l of reverse-transcribed cellular RNA are added. To compare the levels of mRNA in cells treated for different times without or with LPS or MTP-PE,  $\beta$ -actin is chosen to standardize the different samples. mRNA levels encoding  $\beta$ -actin did not change upon treatment of macrophages with LPS or MTP-PE (data not shown). In previous experiments, using different amounts of RNA and different amplification cycles, the amount of RNA for the different PCR reactions was then chosen so that the amount of specific amplified products increased roughly logarithmically between 25 and 35 cycles. Final PCR conditions are as followed (Perkin Elmer PCR System 2400):

$\beta$ -actin [1 ng cDNA, 0.5  $\mu$ M primer

(CTCCTTAATGTCACGCACGATTTTC/  
GTGGGGCGCCCCAGGCACCA),

94°C/5 min, 52°C /5 min–72°C/2 min–94°C/1 min  
(30 cycles)–52°C/2 min–72°C/10 min–4°C];

TNF- $\alpha$  [100 ng cDNA, 0.5  $\mu$ M primer

(ATGAGCACAGAAAGCATGATC/  
CAGAGCAATGACTCCAAAGTA),

94°C/5 min, 52°C/5 min–72°C/2 min–94°C/1 min–  
52°C/2 min (30 cycles)–72°C/10 min–4°C];

COX-1 [10 ng cDNA, 0.5  $\mu$ M primer

(TGCAATGGCTGTGGAGTTCATCAA/  
CACTAAGACAGACCCGTCTTCTCCA),

94°C/5 min, 65°C /5 min–72°C/2 min–94°C/1 min–  
65°C/2 min (30 cycles)–72°C/10 min–4°C];

COX-2 [100 ng cDNA, 0.5  $\mu$ M primer

(ACTCACTCAGTTTGTGAGTCATTC/  
TTTGATTAGTACTGTAGGGTAAATG),

94°C/5 min, 55°C/5 min–72°C/2 min–94°C/1 min–  
55°C/2 min (30 cycles)–72°C/10 min–4°C];

iNOS [100 ng cDNA, 500 ng primer

(GCTTGCCCCTGGAAGTTTCTC/  
CCGACCTGATGTTGCCACTGT),

94°C/5 min, 65°C/5 min–72°C/2 min–94°C/1 min–  
65°C/2 min (30 cycles)–72°C/10 min–4°C]. 10  $\mu$ l of the PCR reaction are loaded onto a 1.5% agarose gel. The bands ( $\beta$ -actin: 610 bp, TNF- $\alpha$ : 710 bp, COX-2:

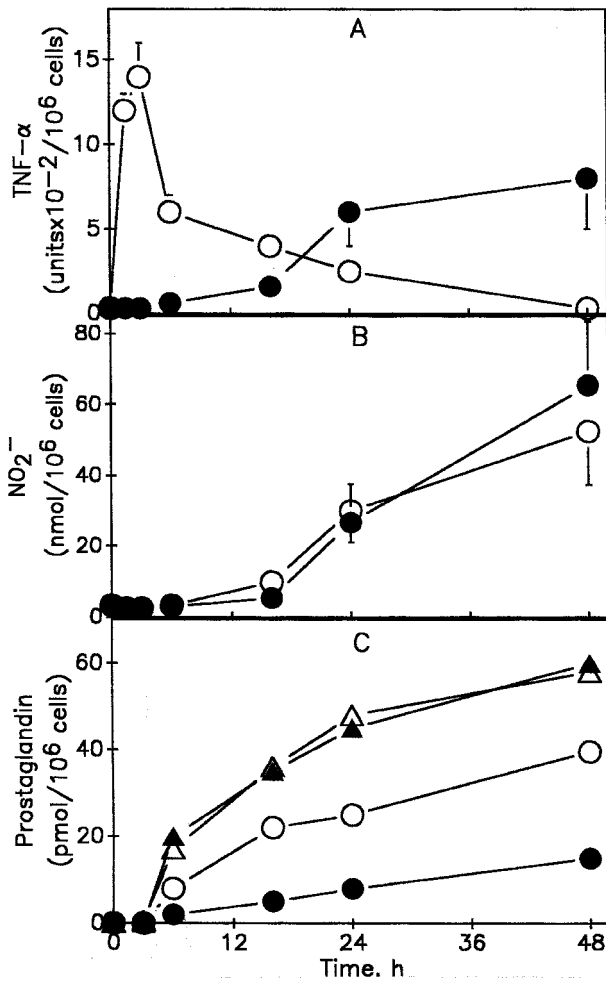

FIG. 1. Effect of LPS and MTP-PE on the release of TNF- $\alpha$ , nitric oxide, PGE<sub>2</sub> and PGD<sub>2</sub>. Macrophages are incubated for the indicated times in RPMI medium containing 10% newborn calf serum with LPS (open symbols, 500 ng/ml) or with MTP-PE (closed symbols, 25  $\mu$ g/ml). At indicated time points, accumulation of TNF- $\alpha$  activity (A), nitric oxide (B), PGE<sub>2</sub> (C, circles), and PGD<sub>2</sub> (C, triangles) in cell media is determined as described in Materials and Methods. Values represent means  $\pm$  SD of four experiments.



FIG. 2. RT-PCR analysis of mRNA isolated from unstimulated macrophages. Macrophages are cultured for 72 h in RPMI medium containing 10% newborn calf serum. RNA is isolated and RT-PCR analysis is performed as described in Materials and Methods. Marker,  $\phi$ X174/Hae III (1353, 1078, 872, 603, 310 bp). A representative set of experiments is shown which is reproduced at least six times.

583 bp, iNOS: 818 bp) are visualized on a transilluminator after ethidium bromide staining and, for semi-quantitative analysis, scanned densitometrically (E.A.S.Y. RH, Herolab, Germany). To compare mRNA expression in cells treated different times with or without LPS or MTP-PE, corresponding mRNA levels are first calculated as expression compared to  $\beta$ -actin mRNA, the resulting values of control cells are set to 1 and levels of mRNA in LPS- and MTP-PE-treated cells are expressed as 'fold of control cells'.

## Results

### Release of TNF- $\alpha$ , nitric oxide and prostaglandins

LPS and MTP-PE induce a synthesis and release of TNF- $\alpha$ , nitric oxide and prostanoids in macrophages (Fig. 1). LPS induces a rapid and transient accumulation

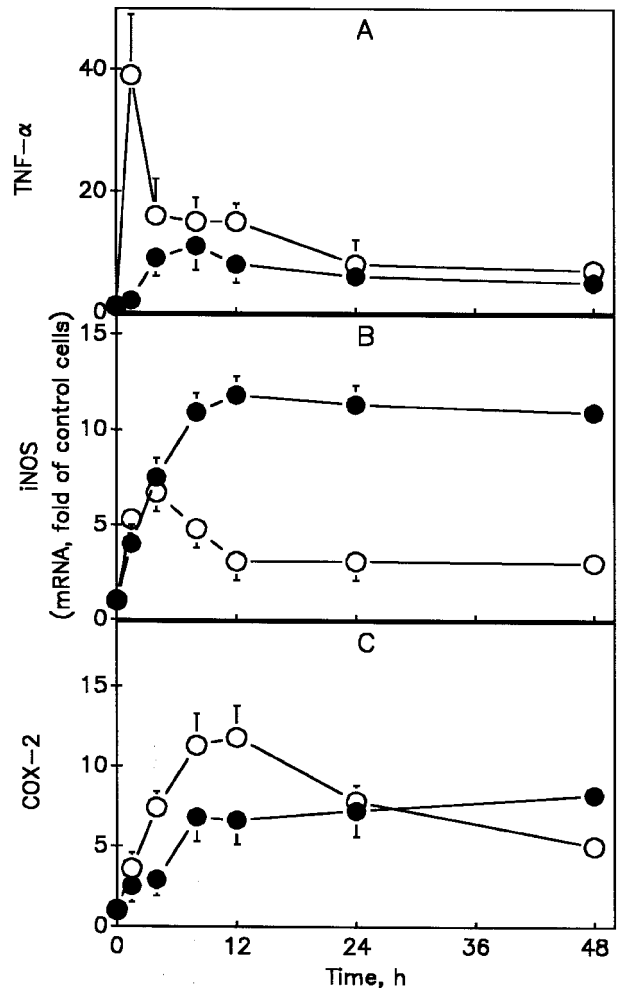

FIG. 3. Effect of LPS and MTP-PE on the accumulation of mRNA encoding TNF- $\alpha$ , iNOS and COX-2. Macrophages are incubated for the indicated times in RPMI medium containing 10% newborn calf serum with LPS (open circles, 500 ng/ml) or with MTP-PE (closed circles, 25  $\mu$ g/ml). At indicated time points, RNA is isolated and RT-PCR analysis is performed as described in Materials and Methods. Values represent means  $\pm$  SD of four experiments.

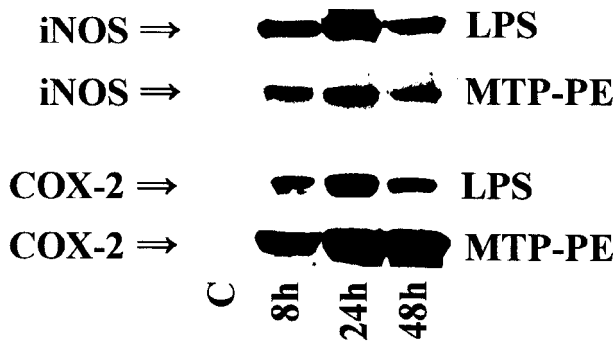

FIG. 4. Western blot analysis of iNOS and COX-2. Macrophages are incubated in RPMI medium containing 10% newborn calf serum without (C), with LPS (500 ng/ml) or with MTP-PE (25 µg/ml). At indicated time points, protein is isolated and Western blot analysis is performed as described in Materials and Methods. A representative set of experiments is shown, which is reproduced at least three times.

of TNF-α, MTP-PE-induced TNF-α release shows a lag phase of about 6 h, and increases thereafter up to 48 h (Fig. 1A). The release of nitric oxide (Fig. 1B) and PGD<sub>2</sub> (Fig. 1C) is almost identical for both agents. The release of PGE<sub>2</sub> after LPS is higher than after MTP-PE (Fig. 1C).

**mRNA and protein levels**

In order to investigate at which levels LPS and MTP-PE induce the formation of TNF-α, nitric oxide and prostanoids, corresponding mRNA and protein levels are determined by RT-PCR and Western blot analysis, respectively. Figure 2 shows that unstimulated macrophages contain very small amounts of mRNAs encoding TNF-α, iNOS and COX-2. mRNAs encoding β-actin and COX-1 are expressed at much higher levels (Fig. 2). LPS induces a rapid and transient accumulation of TNF-α mRNA with a maximum at about 1.5 h (Fig. 3A). In contrast, TNF-α mRNA after MTP-PE becomes detectable only after a lag phase of about 4 h. Both,

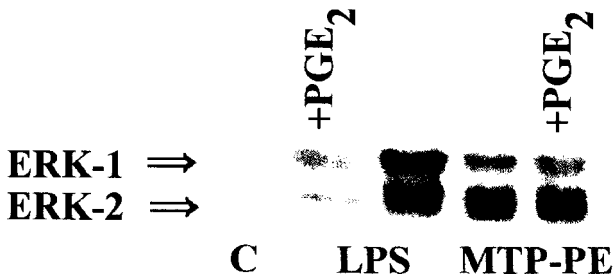

FIG. 5. Effect of LPS, MTP-PE and PGE<sub>2</sub> on map kinase isoenzymes ERK-1 and ERK-2. Macrophages are incubated in Hanks' solution without or with PGE<sub>2</sub> (1 µM) as indicated. After 10 min, vehicle (C), LPS (500 ng/ml) or MTP-PE (25 µg/ml) is added for another 10 min. Thereafter, cells are lysed, subjected to SDS-PAGE, and an 'in gel kinase assay' is performed as described in Materials and Methods. The position of the map kinase isoenzymes ERK-1 and ERK-2 is indicated. A representative set of experiments is shown, which is reproduced at least three times. PGE<sub>2</sub> alone is without any effect.

**Table 1.** Effect of PD 98059 and BAY 11-7082 on the release of TNF-α, nitric oxide and PGE<sub>2</sub><sup>a</sup>

Treatment	TNF-α	Nitric oxide (% of control cells)	PGE <sub>2</sub>
LPS	100	100	100
+PD 98059	2 ± 4	28 ± 9	37 ± 7
+BAY 11-7082	1 ± 2	4 ± 5	40 ± 11
MTP-PE	100	100	100
+PD 98059	1 ± 2	69 ± 12	1 ± 2
+BAY 11-7082	111 ± 2	128 ± 29	159 ± 38

<sup>a</sup>Macrophages (48 h) are incubated in RPMI medium containing 10% newborn calf serum in the absence or presence of PD 98059 (10 µM, 4 h) or BAY 11-7082 (10 µM, 1 h). Thereafter, LPS (500 ng/ml) or MTP-PE (25 µg/ml) is added. TNF-α is measured 4 h after LPS and 24 h after MTP-PE; NO<sub>2</sub><sup>-</sup> and PGE<sub>2</sub> are measured 24 h after LPS and MTP-PE in cell media as described in Materials and Methods. Values represent means±SD of four to seven experiments.

LPS and MTP-PE induce a rapid accumulation of iNOS mRNA (Fig. 3B). The level of iNOS mRNA after LPS peaks at about 4 h, and declines thereafter. In contrast, MTP-PE induces an increase of iNOS mRNA up to 12 h, which remains thereafter elevated at this level. COX-2 mRNA increases rapidly to similar levels after the addition of LPS and MTP-PE (Fig. 3C). Resting macrophages show no detectable amounts of iNOS and COX-2 protein (Fig. 4). Addition of LPS and MTP-PE induce an expression of both proteins, which becomes detectable at first after 6–8 h. LPS induces a higher expression of iNOS protein (24 h), COX-2 protein is higher expressed after MTP-PE.

**Activation of ERK-1 and -2**

Recently we demonstrated that calcium and protein kinase C isoenzymes are not involved in the actions of LPS and MTP-PE in macrophages.<sup>21</sup> Here we show (Fig. 5), that both agents induce a rapid activation of the map kinase isoenzymes extracellular regulated kinase (ERK)-1 and ERK-2.

**Activation of NF-κB and AP-1**

LPS induces a rapid activation of the transcription factors NF-κB and AP-1 (Fig. 6). No activation of both transcription factors at this early time-point is seen with MTP-PE. Activation of NF-κB and AP-1 by MTP-PE becomes detectable only after a lag phase of about 5 h, and is weaker pronounced than with LPS.

**Effect of inhibitors of ERK-1, -2 and NF-κB on the release of TNF-α, nitric oxide and PGE<sub>2</sub>**

Inhibition of the map kinase isoenzymes ERK-1 and ERK-2 by PD 98059<sup>29</sup> leads to a decreased release of TNF-α, nitric oxide and PGE<sub>2</sub> (Table 1). TNF-α release after LPS and MTP-PE, and PGE<sub>2</sub> release after MTP-PE is

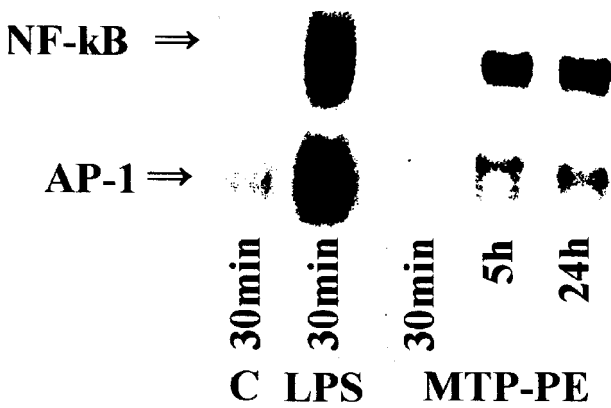

FIG. 6. Activation of NF-κB and AP-1. Macrophages are incubated in Hanks' solution without (C), with LPS (500 ng/ml), or with MTP-PE (25 μg/ml) for the indicated times. Thereafter, cells are extracted and DNA binding activity to NF-κB and AP-1 is monitored in electrophoretic mobility shift assays as described in Materials and Methods. A representative set of experiments is shown, which is reproduced at least three times.

completely inhibited by PD 98059. The release of nitric oxide after LPS and MTP-PE, and of PGE<sub>2</sub> after MTP-PE, is inhibited by PD 98059 by about 70%, 30% and 60% respectively (Table 1). Inhibition of the transcription factor NF-κB by BAY 11-7082<sup>30</sup> has no effect on the MTP-PE-induced release of TNF-α, nitric oxide and PGE<sub>2</sub> (Table 1). However, the LPS-induced release of TNF-α and nitric oxide is completely inhibited by BAY 11-7082. The release of PGE<sub>2</sub> after LPS is inhibited by BAY 11-7082 by about 60% (Table 1).

### Effect of PGE<sub>2</sub> and PGD<sub>2</sub>

PGE<sub>2</sub>, exogenously added to macrophages, inhibits TNF-α release by LPS but not by MTP-PE (Table 2). In

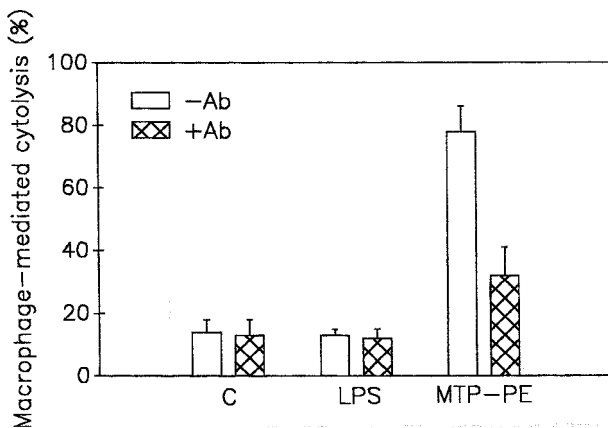

FIG. 7. Effect of LPS and MTP-PE on cytotoxicity of macrophages against P815 tumor target cells. Macrophages (48 h in primary culture) are incubated for 6 h in RPMI medium containing 10% newborn calf serum without (C), with LPS (500 ng/ml) or with MTP-PE (25 μg/ml). Thereafter, P815 target cells, and TNF-α neutralizing antibodies (Ab, 10 μl), as indicated, are added. 48 h later, cytotoxicity is determined as described in Materials and Methods. Values represent means ± SD of five experiments.

Table 2. Effect of PGE<sub>2</sub> and PGD<sub>2</sub> on LPS- and MTP-PE-induced accumulation of TNF-α activity and NO<sub>2</sub><sup>-a</sup>

Treatment	TNF-α activity (Units × 10 <sup>-2</sup> /10 <sup>6</sup> cells)	Nitric oxide (NO <sub>2</sub> <sup>-</sup> , nmol/10 <sup>6</sup> cells)
None	n.d.	n.d.
LPS	20 ± 8	28 ± 11
+PGE <sub>2</sub>	1 ± 3	86 ± 9
+PGD <sub>2</sub>	22 ± 6	31 ± 7
MTP-PE	8 ± 3	26 ± 7
+PGE <sub>2</sub>	10 ± 5	79 ± 10
+PGD <sub>2</sub>	7 ± 4	24 ± 11

<sup>a</sup>Macrophages (48 h) are incubated in RPMI medium containing 10% newborn calf serum without (None), with PGE<sub>2</sub> (1 μM) or with PGD<sub>2</sub> (1 μM). 15 min later, LPS (500 ng/ml) or MTP-PE (25 μg/ml) is added. TNF-α is measured 4 h after LPS and 24 h after MTP-PE; NO<sub>2</sub><sup>-</sup> is measured 24 h after LPS and MTP-PE in cell media as described in Materials and Methods. n.d., not detectable. Values represent means ± SD of four experiments.

contrast, the release of nitric oxide after LPS and MTP-PE is enhanced by prior addition of PGE<sub>2</sub>. PGD<sub>2</sub> is without any effect (Table 2). In order to investigate at which level PGE<sub>2</sub> exerts its action, the effect of exogenously added PGE<sub>2</sub> on the activation of map kinase isoenzymes ERK-1 and ERK-2 is determined. PGE<sub>2</sub> has no effect on the MTP-PE-induced activation of ERK-1 and ERK-2 (Fig. 6). However, map kinase activation by LPS is completely suppressed.

### Effect of LPS and MTP-PE on the cytotoxicity of macrophages

MTP-PE but not LPS activates macrophages to cytotoxicity against P815 tumor target cells (Fig. 7). Addition of neutralizing antibodies against TNF-α reduced the cytotoxic effect of MTP-PE by about 75%, indicating that TNF-α is involved in the cytotoxic reaction.

### Discussion

Here we show that LPS and MTP-PE induce a release of TNF-α, nitric oxide, PGE<sub>2</sub> and PGD<sub>2</sub> in macrophages. Both agents increase mRNA's encoding TNF-α, iNOS and COX-2 indicating their action at the transcriptional level. We demonstrated recently that macrophages do not express constitutive NOS,<sup>31</sup> which suggests that the observed release of nitric oxide after LPS and MTP-PE is catalysed by iNOS. The formation of prostanoids after LPS is probably due to the enhanced expression of COX-2 (Fig. 3C) and an enhanced expression of cytosolic phospholipase A<sub>2</sub>.<sup>31</sup> Since MTP-PE has no effect on cytosolic phospholipase A<sub>2</sub>,<sup>31</sup> prostanoid release after MTP-PE seems to be triggered only by the enhanced expression of COX-2. We could also demonstrate recently that LPS and

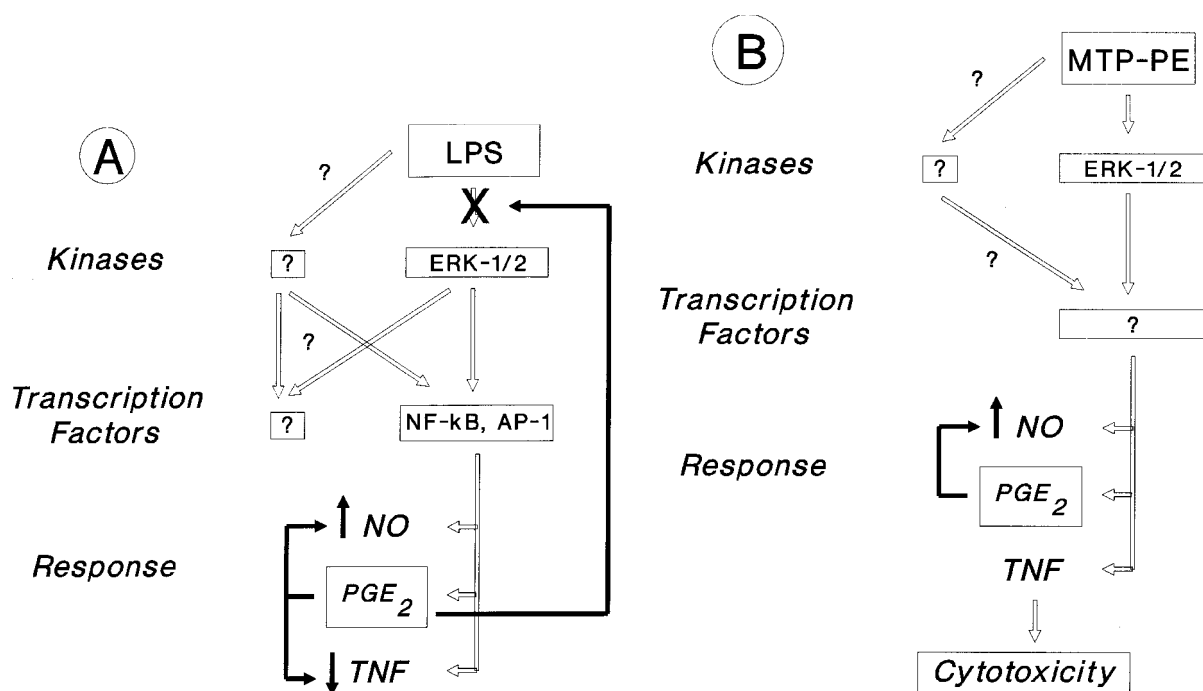

FIG. 8. Tentative scheme for the actions of LPS (A), MTP-PE (B) and PGE<sub>2</sub> in macrophages.

MTP-PE have no effect on COX-1 levels, and that the constitutive nitric oxide synthase and secretory phospholipase A<sub>2</sub>s are not expressed in these cells.<sup>31</sup>

While the release of nitric oxide and PGD<sub>2</sub> is almost identical for both immunomodulators, the formation of TNF- $\alpha$  and PGE<sub>2</sub> after LPS and MTP-PE is different. (1) Accumulation of TNF- $\alpha$  mRNA and TNF- $\alpha$  activity after LPS is transient, a sustained release of TNF- $\alpha$  is induced by MTP-PE. The finding, that PGE<sub>2</sub> inhibits TNF- $\alpha$  release after LPS, but not after MTP-PE (Table 2), indicates that the mechanisms underlying TNF- $\alpha$  formation are different for both immunomodulators. It has been shown recently that the inhibition of the LPS-induced TNF- $\alpha$  release by PGE<sub>2</sub> can be mimicked by cAMP,<sup>4</sup> suggesting that intracellular cAMP mediates the effect of PGE<sub>2</sub>. (2) PGE<sub>2</sub> release after LPS is higher than after MTP-PE. It has been suggested recently that the high PGE<sub>2</sub> formation after LPS might be due to an activation of the PGE<sub>2</sub> synthase.<sup>32,33</sup>

We demonstrated recently that both immunomodulators do not induce an activation of the 'phosphatidylinositol cycle', of protein kinase C isoenzymes or a change of the intracellular calcium concentration.<sup>21</sup> Here, we show that LPS and MTP-PE induce a rapid activation of the map kinase isoenzymes ERK-1 and ERK-2. Inhibition of map kinase by PD 98059 completely suppresses TNF- $\alpha$  release after LPS and MTP-PE, and PGE<sub>2</sub> release after MTP-PE. Release of nitric oxide and PGE<sub>2</sub> after LPS are partially inhibited by PD 98059. These data indicate that activation of the map kinase isoenzymes ERK-1 and ERK-2 is an

essential step for TNF- $\alpha$  release by LPS and MTP-PE, and for PGE<sub>2</sub> formation by MTP-PE. Nitric oxide release, and PGE<sub>2</sub> formation by LPS seem only to be partially mediated by map kinase. In addition, we demonstrate here, that the transcription factors NF- $\kappa$ B and AP-1 are activated by LPS. Activation of both transcription factors by LPS is observed already after 30 min, and persists for more than 24 h.<sup>27</sup> The activation of NF- $\kappa$ B and AP-1 by MTP-PE is much weaker pronounced, and becomes detectable only after 5 h. Since mRNAs encoding TNF- $\alpha$ , iNOS and COX-2 are expressed at much earlier time-points, it is very unlikely that NF- $\kappa$ B and AP-1 are involved in these actions of MTP-PE. This conclusion is supported by the finding that BAY 11-7072, an inhibitor for NF- $\kappa$ B, has no effect on MTP-PE-induced responses. BAY 11-7072 completely suppresses the release of TNF- $\alpha$  and nitric oxide by LPS, and inhibits PGE<sub>2</sub> release by LPS by 60% indicating an involvement of NF- $\kappa$ B in these actions of LPS.

The LPS- but not the MTP-PE-induced release of TNF- $\alpha$  is specifically inhibited by PGE<sub>2</sub>. In contrast, nitric oxide release by LPS and MTP-PE is enhanced by PGE<sub>2</sub>. PGE<sub>2</sub> has been shown earlier to exert its suppressing effect on TNF- $\alpha$  release by LPS at the transcriptional level.<sup>4</sup> However, PGE<sub>2</sub> does not affect the activation of NF- $\kappa$ B or AP-1 by LPS.<sup>27</sup> Here we show, that PGE<sub>2</sub> inhibits map kinase activation by LPS, but not by MTP-PE. This indicates that the mechanisms of LPS and MTP-PE leading to activation of map kinase are different.

MTP-PE, but not LPS, induces a cytotoxicity of macrophages against tumor target cells. The MTP-PE induced cytotoxicity is reduced by TNF- $\alpha$  neutralizing antibodies, indicating that TNF- $\alpha$  is involved in the cytotoxic action. The lack of cytotoxicity after LPS might be due to the transient release of TNF- $\alpha$ , in contrast to the sustained accumulation of TNF- $\alpha$  after MTP-PE. These findings are in line with the fact, that MTP-PE, when administered i.v., induces an antitumor reactivity in animal models.<sup>16–20</sup> Recently, it has been proposed that the cytotoxicity of macrophages against the adenomacarcinoma line MCA26 is mediated by TNF- $\alpha$ , and not by nitric oxide.<sup>34</sup> Our data support these findings, since LPS and MTP-PE induce an identical release of nitric oxide, but differ in their cytotoxic potencies.

Based on the results presented here, we propose the following scheme for the regulatory role of PGE<sub>2</sub> in the action mechanisms of LPS and MTP-PE in macrophages (Fig. 8). LPS (Fig. 8A) activates rapidly the map kinase isoenzymes ERK-1 and ERK-2 and the transcription factors NF- $\kappa$ B and AP-1, which results in a synthesis and release of nitric oxide, TNF- $\alpha$  and PGE<sub>2</sub>. PGE<sub>2</sub> reduces in a negative feedback loop the activation of ERK-1 and ERK-2, nitric oxide release is enhanced, TNF- $\alpha$  formation is suppressed, cytotoxicity against tumor target cells is low. MTP-PE activates rapidly map kinase isoenzymes ERK-1 and ERK-2, but not the transcription factors NF- $\kappa$ B and AP-1. Activation of yet unknown transcription factors results in a synthesis and release of nitric oxide, TNF- $\alpha$  and PGE<sub>2</sub>. PGE<sub>2</sub> has no inhibitory effect on the map kinase isoenzymes ERK-1 and ERK-2, TNF- $\alpha$  release is not suppressed, and the macrophages show a high cytotoxicity against tumor target cells. Further experiments have to be carried out to elucidate in detail the molecular mechanisms of the regulatory function of PGE<sub>2</sub>. These experiments include the investigation of other kinases and other transcription factors,<sup>35–38</sup> which have been demonstrated in other cells to be involved in the action of LPS, and in the formation of TNF- $\alpha$ , nitric oxide and eicosanoids.

**ACKNOWLEDGEMENTS.** This work was supported by grants from the Deutsche Forschungsgemeinschaft (Di 357/7–1/8–1), the Dr Mildred Scheel Stiftung für Krebsforschung (W 35/93/Di 1), and the Ministerium für Wissenschaft und Forschung Baden-Württemberg (II-729.55–5-2/17). We gratefully acknowledge the assistance of Mrs Kathryn Asman in the preparation of the manuscript.

## References

- Decker K. Biologically active products of stimulated liver macrophages (Kupffer cells). *Eur J Biochem* 1990; **192**:245–61
- Duyster J, Schwende H, Fitzke E, Hidaka H, Dieter P. Different roles of PKC $\beta$  and  $\zeta$  in arachidonic acid cascade, superoxide formation and phosphoinositide hydrolysis. *Biochem J* 1993; **292**:203–7
- Gaillard T, Mülsch A, Klein H, Decker K. Regulation by PGE<sub>2</sub> of cytokine-elicited nitric oxide synthesis in rat liver macrophages. *Biol Chem Hoppe-Seyler* 1992; **373**:897–902
- Grewé M, Gausling R, Guyfko K, Hoffmann R, Decker K. Regulation of mRNA expression for tumor necrosis factor. *J Hepatol* 1994; **20**:811–18
- Dieter P, Fitzke E. Formation of diacylglycerol, inositol phosphates, arachidonic acid and its metabolites in macrophages. *Eur J Biochem* 1993; **218**:753–8
- Busam KJ, Homfeld A, Zawatzky R, Bauer J, Gerok W, Decker K. Virus-vs endotoxin-induced activation of liver macrophages. *Eur J Biochem* 1990; **191**:577–82
- Busam KJ, Schulze-Specking A, Decker K. Endotoxin-refractory liver macrophages secrete tumor necrosis factor- $\alpha$  upon viral infection. *Biol Chem Hoppe-Seyler* 1991; **372**:157–62
- Lederer E, Adam A, Ciorbaru R, Petit JE, Wietzerbin, J. Cell walls of mycobacteria and related organisms: chemistry and immunostimulant properties. *J Mol Cell Biochem* 1975; **7**:87–92
- Ellouz F, Adam A, Ciorbaru R, Lederer E. Minimal structural requirements for adjuvant activity of bacterial peptidoglycan derivatives. *Biochem Biophys Res Commun* 1974; **59**:1317–22
- Landmann R, Obrist R, Denz H, et al. Pharmacokinetics and immunomodulatory effects on monocytes during prolonged therapy with liposomal muramyl tripeptide. *Biotherapy* 1994; **7**:1–12
- Freudenberg MA, Freudenberg N, Galanos G. Time course of cellular distribution of endotoxin in liver, lung and kidney of rats. *Br J Exp Pathol* 1982; **63**:56–61
- Freudenberg MA, Galanos G. Metabolism of LPS *in vivo*. In: Morrison DC, Ryan JL, eds *Bacterial Endotoxin Lipopolysaccharides*. Vol. 2. Boca Raton, FL: CRC Press, 1992: 275–85.
- Fogler WE, Wade R, Brundish DE, Fidler IJ. Distribution and fate of free and liposome-encapsulated [<sup>3</sup>H]muramyl dipeptide and [<sup>3</sup>H]muramyl tripeptide phosphatidylethanolamine in mice. *J Immunol* 1985; **135**:1372–9
- Izbicki JR, Raedler C, Anke A, et al. Beneficial effect of liposome-encapsulated muramyl tripeptide in experimental septicemia in a porcine model. *Infect Immun* 1991; **59**:126–30
- Ziegler-Heitbrock HWL, Passlick B., Käferlein E, Coulie PG, Izbicki JR. Protection against lethal pneumococcal septicemia in pigs is associated with decreased levels of interleukin-6 in blood. *Infect Immun* 1992; **60**:1692–4
- Frost H. MTP-PE in liposomes as a biological response modifier in the treatment of cancer: current studies. *Biotherapy* 1992; **4**:199–204
- Fidler IJ, Kleiner ES. Clinical application of phospholipid liposomes containing macrophage activators for therapy of cancer metastasis. *Adv Drug Del Rev* 1994; **13**:325–40
- Thomas K, Nijenhuis AM, Dontje BHJ, Daemen T, Scherphof GL. Antitumor reactivity induced by liposomal MTP-PE in a liver metastasis model of colon cancer in the rat. *Clin Exp Metastasis* 1995; **13**:328–36
- Killion JJ, Fidler IJ. Therapy of cancer metastasis by tumoricidal activation of tissue macrophages using liposome-encapsulated immunomodulators. *Pharmacol Ther* 1998; **78**:141–54
- Lazdins JK, Woods-Cook K, Walker M, Alteri, E. The lipophilic muramyl peptide MTP-PE is a potent inhibitor of HIV replication in macrophages. *Aids Res Hum Retroviruses* 1990; **6**:1157–61
- Dieter P, Ambs P, Fitzke E, Hidaka H, Hoffmann R, Schwende, H. Comparative studies of cytotoxicity and the release of TNF- $\alpha$ , nitric oxide, and prostanoids of liver macrophages treated with lipopolysaccharide and liposome-encapsulated MTP-PE. *J Immunol* 1995; **155**:2595–604
- Eyhorn S, Schlayer HJ, Henninger HP, et al. Rat hepatic sinusoidal cells in monolayer culture. *J Hepatology* 1988; **6**:23–35
- Dieter P, Schulze-Specking A, Karck U, Decker K. Prostaglandin release but not superoxide production by dexamethasone in rat Kupffer cells stimulated *in vitro* depends on Na<sup>+</sup>/H<sup>+</sup> exchange. *Eur J Biochem* 1987; **170**:201–6
- Flick DA, Gifford GE. Comparison of *in vitro* cell cytotoxicity assays for tumor necrosis factor. *J Immunol Methods* 1984; **68**:167–73
- Buscher D, Hipskind RA, Krautwald S, Reimann T, Baccarini, M. Ras-dependent and -independent pathways target the mitogen-activated protein kinase network in macrophages. *Mol Cell Biol* 1995; **15**:466–75
- Ambs P, Baccarini M, Fitzke E, Dieter P. Role of cytosolic phospholipase A<sub>2</sub> in arachidonic acid release of rat-liver macrophages: regulation by Ca<sup>2+</sup> and phosphorylation. *Biochem J* 1995; **223**:189–95
- Tran-Thi TA, Decker K, Baeuerle PA. Differential activation of transcription factors NF- $\kappa$ B and AP-1 in rat liver macrophages. *Hepatology* 1995; **22**:613–18
- Chomzynski P, Sacchi N. Single-step method of RNA isolation by acid guanidinium thiocyanate-phenol-chloroform extraction. *Ann Biochem* 1987; **162**:156–61
- Dudley DT, Pang L, Decker SJ, Bridges AJ, Saltiel AR. A synthetic inhibitor of the mitogen-activated protein kinase cascade. *Proc Natl Acad Sci USA* 1991; **15**:7686–9
- Pierce JW, Schoenleber R, Jesmok G, et al. Novel inhibitors of cytokine-induced I(B)phosphorylation and endothelial cell adhesion molecule expression show anti-inflammatory effects *in vivo*. *J Biol Chem* 1997; **272**:21096–103
- Dieter P, Hempel U., Kamionka S, et al. Lipopolysaccharide and liposome-encapsulated muramyl tripeptide. In: Wisse E, Knook DL, De Zanger R, Frazer R, eds *Cells of the Hepatic Sinusoid Vol. 7*. Leiden: The Kupffer Cell Foundation Leiden, 1999; 257–9



32. Peter T, Karcz U, Decker K. Interdependence of tumor necrosis factor, prostaglandin E<sub>2</sub>, and protein synthesis in lipopolysaccharide-exposed rat Kupffer cells. *Eur J Biochem* 1990; **191**:583–6
33. Grewe M, Duyster J, Dieter P, Henninger HP, Schulze-Specking A, Decker K. Prostaglandin D<sub>2</sub> and E<sub>2</sub> synthases in rat Kupffer cells are antagonistically regulated by lipopolysaccharide and phorbol ester. *Biol Chem Hoppe-Seyler* 1992; **373**:655–9
34. Foletta VC, Segal DH, Cohen DR. Transcriptional regulation in the immune system: all roads lead to AP-1. *J Leucocyte Biol* 1998; **63**:139–43
35. Hobbie S, Chen LM, Davis, RJ, Galan JE. Involvement of mitogen-activated protein kinase pathways in the nuclear responses and cytokine production by *Salmonella typhimurium* in cultured intestinal epithelial cells. *J Immunol* 1997; **159**:5550–9
36. Chan ED, Winston BW, Uh SZ, Wynes MW, Rose DM, Rches DW. Evaluation of the role of mitogen-activated protein kinases in the expression of inducible nitric oxide synthase by IFN- $\gamma$  and TNF- $\alpha$  in mouse macrophages. *J Immunol* 1999; **162**:415–22
37. Faure V, Hecquet C, Courtois Y, Goureau O. Role of interferon regulatory factor-1 and mitogen-activated protein kinase pathways in the induction of nitric oxide synthase-2 in retinal pigmented epithelial cells. *J Biol Chem* 1999; **19**:4794–800
38. Goppelt-Strube M, Hahn A, Stroebel M, Reiser COA. Independent regulation of cyclo-oxygenase 2 expression by 42/44 mitogen-activated protein kinases and Ca<sup>2+</sup>/calmodulin-dependent kinase. *Biochem J* 1999; **339**:329–34

Accepted 24 January 2000



**Hindawi**  
Submit your manuscripts at  
<http://www.hindawi.com>

