

Research Article

Gamma Decay Heat Distribution in Core: A Known Issue Revisited

Gianni Petrangeli and Calogero Sollima

University of Pisa, Italy

Correspondence should be addressed to Gianni Petrangeli, g.petrangeli@gmail.com

Received 2 November 2007; Revised 25 March 2008; Accepted 23 June 2008

Recommended by Horst Glaeser

Decay heat in fission reactors is almost equally subdivided into two parts, one part due to beta rays and the other due to gamma photons. Beta rays are absorbed practically where they are generated while gamma photons travel some distance in core before being absorbed. The decay power peaking factor is, in fact, affected by this phenomenon of gamma decay heat redistribution. Calculations have been performed by the Monte Carlo MCNP5 computer code on the experimental LOFT reactor and on a larger 1000 MWe PWR using various initial power distributions with variable power peak sharpness (midheight peak width). The results indicate that an average peak energy reduction ratio of 0.82 for gamma (18% peak reduction) can be used with tolerable error up to a midheight width of the produced energy peak (neutron flux shape during operation) of 120 cm. Beyond this value, no peak energy reduction is warranted. This phenomenon of absorbed γ power redistribution in core may be very significant (100 to 150°K reduction in calculated PCT).

Copyright © 2008 G. Petrangeli and C. Sollima. This is an open access article distributed under the Creative Commons Attribution License, which permits unrestricted use, distribution, and reproduction in any medium, provided the original work is properly cited.

1. BACKGROUND AND OVERVIEW

Decay heat in fission reactors [1, Chapter 3-2] is almost equally subdivided into two parts, one part due to beta rays and the other due to gamma photons. This fact is not important for the overall thermal balance of the reactor but it is important for the decay power distribution within the core and for the possible overheating of the so called “hot rod” during an accident. Beta rays are absorbed practically where they are generated while gamma photons travel some distance in core before being absorbed. The decay power peaking factor is, in fact, decreased by this phenomenon of gamma decay heat redistribution. If a power peak exists during reactor operation, this power peak is attenuated during shutdown. This fact should be taken into account in transient and accident analyses (and particularly in best-estimate analyses) since it can be very relevant for some interesting quantities and in particular for the calculated peak cladding temperature (PCT).

Also appendix K to Part 50 of the U.S. C.F.R. states (5) that “The fraction of the locally generated gamma energy that is deposited in the fuel (including the cladding) may be

different from 1.0; the value used will be justified by a suitable calculation.”

The present communication is intended to recall the order of magnitude of this effect and to recommend attention to it in the current practice. Two main assumptions of this study are that the operation history at power can be assumed as a continuous, long duration, operation at nominal power (as frequently it is the case). Consideration is given to decay heat produced by the core after the decay of delayed neutrons following shut-down.

2. GAMMA DECAY HEAT SOURCE

Gamma photons due to decay of fission products are usually grouped into seven energy groups.

Table 1 shows these groups (from Perkins and King [2], and Etherington [3]).

Table 2. shows the properties of the various groups at two times after fission, 100 and 10000 seconds, particularly relevant for accident studies (from Perkins and King [2]).

The average energy per disintegration is, for 100 seconds, 1.33 Mev/dis. while, for 10000 seconds, it is 1.07 Mev/dis.

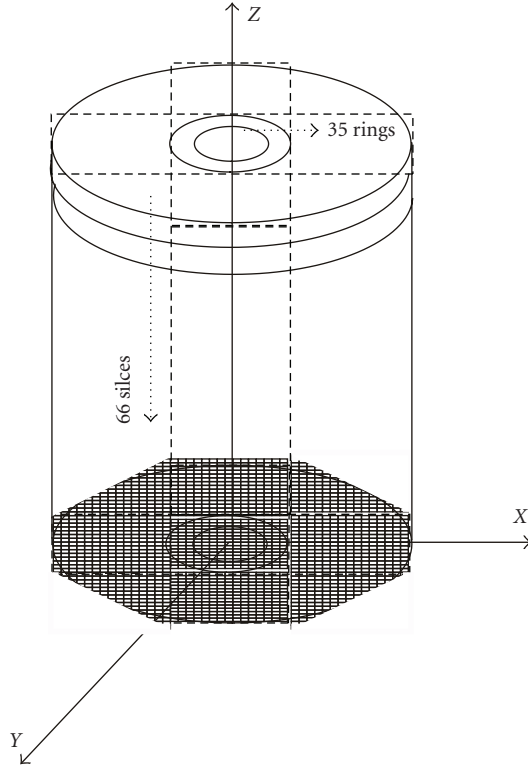

FIGURE 1: cylindrical core model with LOFT grid.

3. MODEL AND CALCULATION CASES

The simple model used for a reactor is a homogeneous cylinder subdivided into 35 cylindrical rings and into 66 slices normal to the axis, Figure 1. The fuel elements grid for loss-of-fluid Test (LOFT, [4]) core is also shown. The density chosen is an average one (by the way, the result is dependent, but less than linearly, on density, because of the “build-up effect” in γ attenuation). The normal operation power distribution has been simulated by a sinusoidal curve both in the radial and in the axial directions. For the radial distribution, other shapes have been explored: the hot rod (simulated by a 1.4 factor energy peak in the central ring superimposed on a sinusoidal distribution for the whole core) and three Gaussian distributions for the whole core with σ^2 equal to 0.01 (narrow), 0.05 (intermediate), 0.12 (wide), and 0.24 (extra wide). The spectrum of γ photons has been taken into account.

The well known Monte Carlo code MCNP5 has been used for the calculation of the distribution in the core of the absorbed γ photons energy corresponding to the γ photons produced energy, distributed as above mentioned.

The cases calculated are as follows:

- (i) small reactor (LOFT) at 100 seconds after shutdown with sinusoidal distribution,
- (ii) small reactor (LOFT) at 10000 seconds after shutdown with sinusoidal distribution,
- (iii) small reactor (LOFT) at 100 seconds after shutdown with hot rod rod (simulated by multiplication of the

TABLE 1: Groups of decay γ photons and energies.

Group	Energy range (Mev)	Effective energy (Mev)
I	0.1–0.4	0.4
II	0.4–0.9	0.8
III	0.9–1.35	1.3
IV	1.35–1.8	1.7
V	1.8–2.2	2.2
VI	2.2–2.6	2.5
VII	>2.6	2.8

γ power in the central cylindrical cell by the factor 1.4),

- (iv) small reactor (LOFT) at 100 seconds after shutdown with intermediate Gaussian distribution ($\sigma^2 =$ square of the standard deviation = 0.05),
- (v) small reactor (LOFT) at 100 seconds after shutdown with wide Gaussian distribution ($\sigma^2 = 0.12$),
- (vi) large reactor with sinusoidal distribution,
- (vii) large reactor with hot rod (simulated by multiplication of the γ power in the central cylindrical cell by the factor 1.4) at 100 seconds,
- (viii) large reactor with narrow Gaussian distribution ($\sigma^2 = 0.01$),
- (ix) large reactor with very wide Gaussian distribution ($\sigma^2 = 0.24$).

The main results are the following:

- (i) the maximum γ power absorbed in the core is significantly decreased when the γ photon redistribution is taken into account. Since the decay heat is due for one half to γ and for the other half to β rays, a certain reduction in absorbed γ power translates in a reduction of one half of it in $\gamma + \beta$ (total) decay power. In particular,
 - (i) for the small reactor without hot rod the reduction of absorbed γ power versus produced power is equal to about 10% at 100 seconds and to about 15% at 10000 seconds after shutdown; the case of a large reactor with local neutron flux hills (due, e.g., to specific control rod management strategies) can approximate the case of a small reactor;
 - (ii) for the small reactor with hot rod, the γ peak at the hot rod practically disappears and the overall (sine distribution plus hot rod) reduction in peak energy is equal to about 30% at 100 seconds (this is considered the most significant result since the γ redistribution, with corresponding $\gamma + \beta$ power decrease of 15%, may entail a calculated PCT reduction of the order of 100–150°K); for a large reactor, the peak energy is reduced by a 12% instead of 30%;

TABLE 2: Properties of photon groups.

Time after fission (s)	100				10000		
	Group	(Mev/s fission)	Disintegr./s	% or probability	(Mev/s fission)	Disintegr./s	% or probability
	I	6e-5	1.5e-4	8	2e-6	5e-6	19
	II	2.4e-4	3e-4	16	1e-5	2.25e-5	48
	III	1.2e-3	9.2e-4	49	2.5e-6	1.9e-6	7
	IV	4.2e-4	2.5e-4	13.4	6e-6	3.5e-6	13
	V	6e-5	2.7e-5	1.45	3.5e-6	1.6e-6	6
	VI	2e-4	8e-5	4.3	3.5e-6	1.4e-6	5.4
	VII	4.2e-4	1.5e-4	8	5e-7	1.8e-7	.7

TABLE 3: Results for time after shutdown of 100 seconds.

$\Delta_{r,1/2}$ (cm)	E_p (w/cm ³)	E_a (w/cm ³)	$(E_p - E_a) / E_p$, %	E_p / E_a	Case
2	3.33	2.34	30	0.7	LOFTh
8.48	3.33	2.94	12	0.88	LGh
18	2.38	1.89	21	0.79	LOFT 0.05
19.5	2.38	2.1	12	0.88	LOFT 0.12
46	2.38	2.16	9	0.9	LOFTsin
67.5	2.38	1.85	22	0.78	LG 0.01
118.4	2.38	2.046	14	0.86	LG 0.24
192.4	2.38	2.36	0.8	0.99	LG sin

(iii) for the large reactor without hot rod the corresponding γ reduction is much lower (about 1% for a sine distribution at 100 seconds).

4. DETAILED RESULTS AND TENTATIVE PRACTICAL RULE FOR THE PEAK ENERGY REDUCTION EVALUATION

Table 3 shows all the results obtained for a time after shutdown of 100 seconds.

In the table the following symbols have been adopted:

- (i) $\Delta_{r,1/2}$ = mid height width of the produced energy peak [cm],
- (ii) E_p = maximum produced specific energy [w/cm³] of photons,
- (iii) E_a = maximum absorbed specific energy [w/cm³] of photons,
- (iv) σ^2 = square of the standard deviation of Gaussian distributions of produced energy,
- (v) LOFT: for LOFT core cases with final letter h for "hot rod" case; sin for sine distribution and a number for σ^2 used,
- (vi) LG: for large reactor with the same meaning of the final letters as for LOFT.

Figures 2, 3, 4, 5 show the distributions (radial and axial) of produced and absorbed energies for LOFT and for LARGE REACTOR with sine distribution.

Figures 6, 7, 8, 9 show the same distributions for the case with hot rod.

An attempt to correlate the maximum energy reduction due to gamma photon redistribution in core has been made:

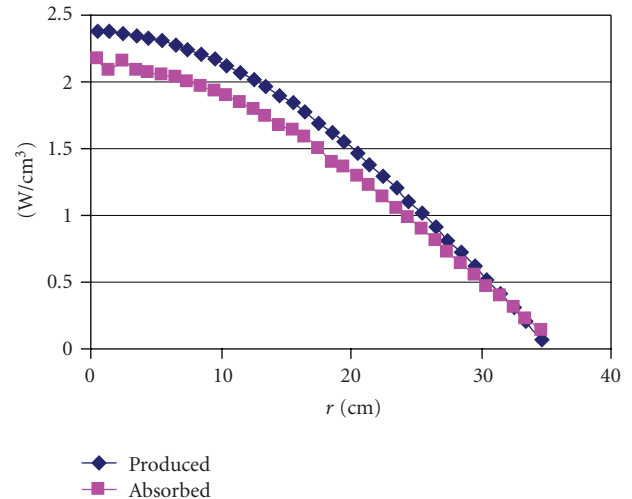

FIGURE 2: LOFT sin, 100 seconds, produced and absorbed power versus radius.

the ratio between maximum absorbed and produced gamma energies has been correlated with the mid-height width of the produced energy peak. Figure 10 has been obtained.

The calculated cases, listed in Table 3, have been used.

As a first approximation, it can be said that the average energy reduction ratio of 0.82 for gamma (18% peak reduction) can be used with tolerable error up to a mid-height width of 120 cm and at 100 seconds after shutdown; at 10000 seconds after shutdown a figure of 77% can be used instead of 82%. Above this value of mid-height width, no peak energy reduction is warranted.

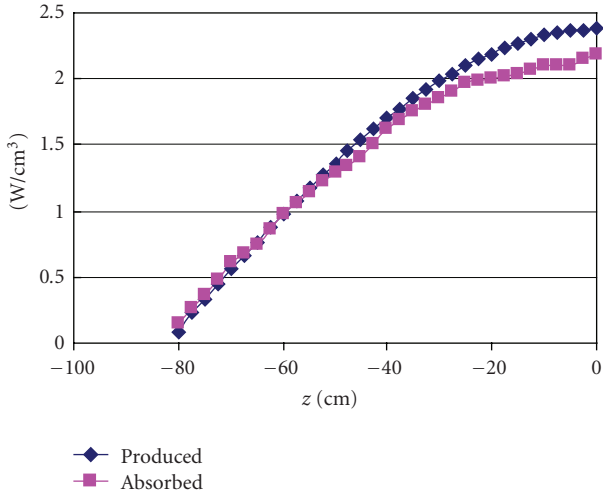

FIGURE 3: LOFT sin, 100 seconds, produced and absorbed power versus height.

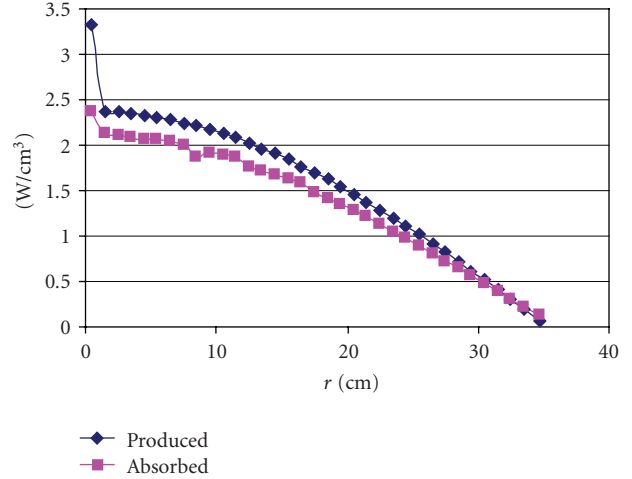

FIGURE 6: LOFT hot rod, 100 seconds, produced and absorbed power versus radius.

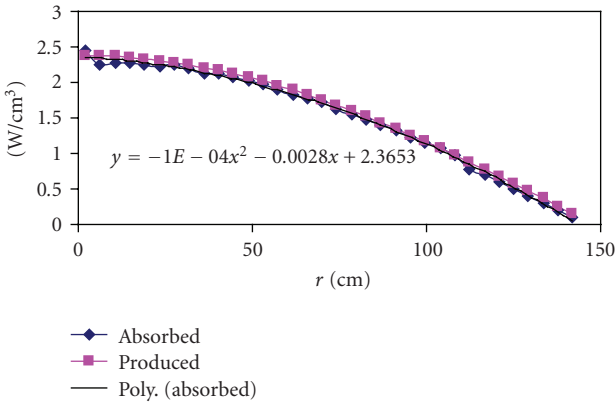

FIGURE 4: LARGE reactor sin, 100 second, produced and absorbed power versus radius.

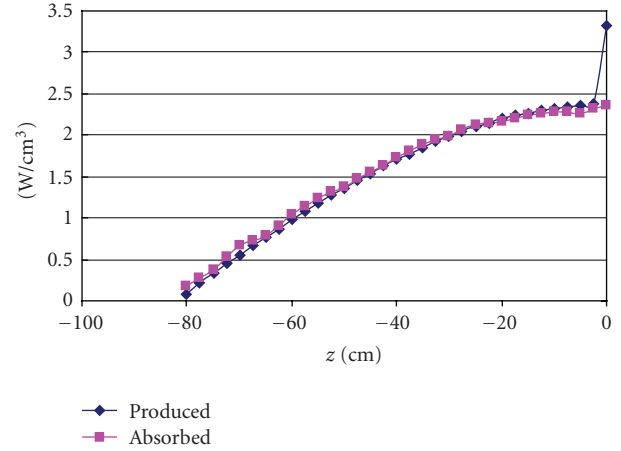

FIGURE 7: LOFT hot rod, 100 seconds, produced and absorbed power versus height.

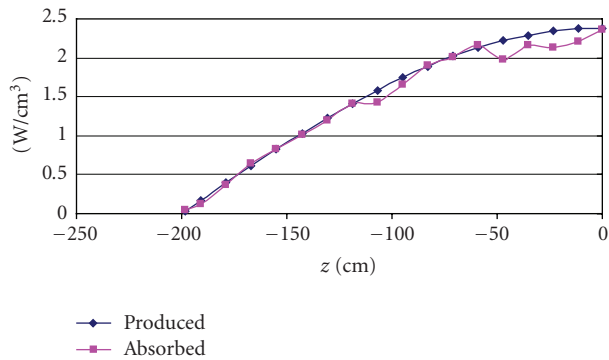

FIGURE 5: LARGE reactor sin, 100 seconds, produced and absorbed power versus height.

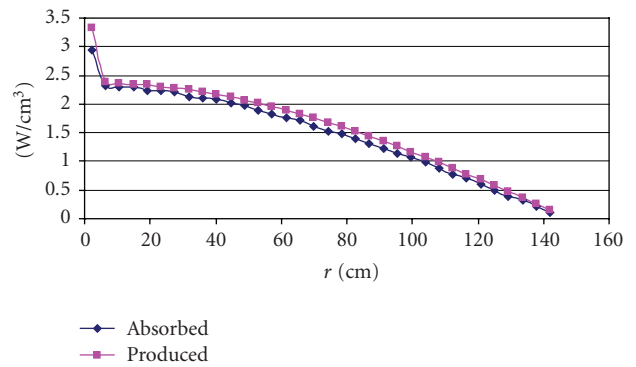

FIGURE 8: LARGE reactor hot rod, 100 seconds, produced and absorbed power versus radius.

5. CONCLUSIONS

The average energy reduction ratio of 0.82 for gamma (18% peak reduction) can be used with tolerable error up to a mid-height width of the produced energy peak (neutron flux

shape during operation) of 120 cm. Beyond this value, no peak energy reduction is warranted.

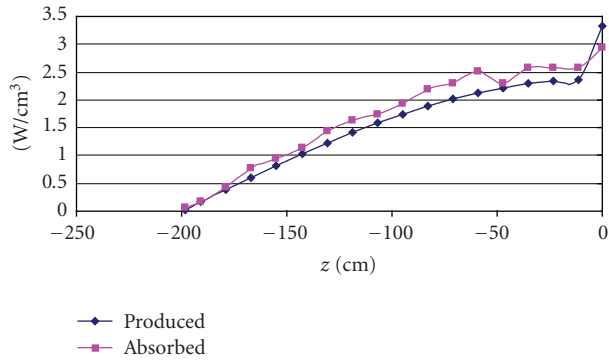

FIGURE 9: LARGE reactor hot rod, 100 seconds, produced and absorbed power versus height.

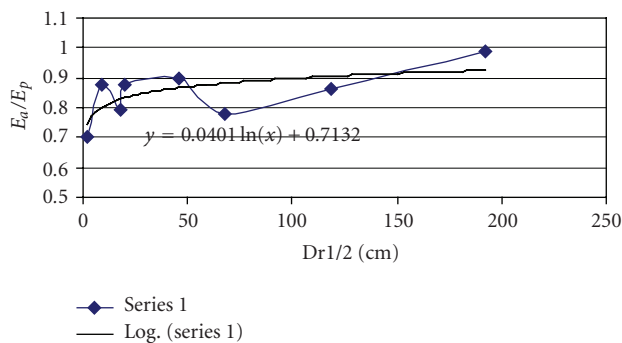

FIGURE 10: Correlation between absorbed and produced energies ratio with mid-height peak width.

The phenomenon of absorbed γ power redistribution in core may be very significant (100 to 150°K reduction in calculated PCT).

A more refined set of calculations than the ones mentioned here (smaller cells, nonhomogeneous core model, etc.) could produce more accurate results; however, for the indicative purpose of this paper and with an accuracy of a few percent in peak photon energy, the results obtained are already sufficient to draw the above mentioned conclusions.

In any case, for any specific reactor and anticipated flux shapes and for any set of similar transients (importance and critical timing of decay heat for hot rod), a specific evaluation is advisable.

ACKNOWLEDGMENT

The contribution of Dr. Eng. Valerio Giusti of DIMNP of the University of Pisa for the use of code MCNP5 is gratefully acknowledged.

REFERENCES

- [1] G. Petrangeli, *Nuclear Safety*, Elsevier, Oxford, UK, 2006.
- [2] J. F. Perkins and R. W. King, "Energy release from the decay of fission products," *Nuclear Science and Engineering*, vol. 3, pp. 726–746, 1958.
- [3] H. Etherington, *Nuclear Energy Handbook*, McGraw Hill, New York, NY, USA, 1958.

- [4] P. D. Bayless, "Experiment data report for LOFT large break loss-of-coolant experiment L2-5," Tech. Rep. NUREG/CR-2826, EGG-2210, p. 317, Nuclear Energy Agency, Paris, France, 1982.

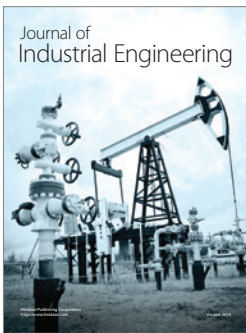
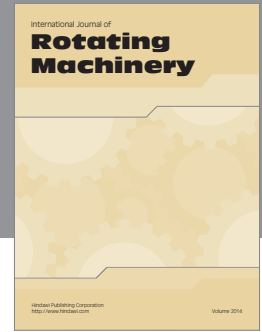
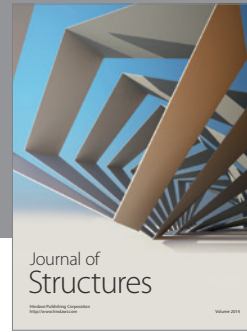
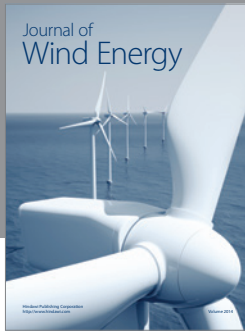
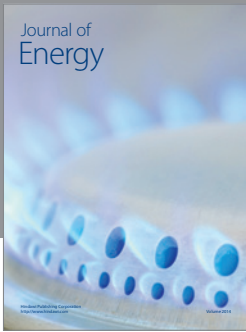

Hindawi

Submit your manuscripts at
<http://www.hindawi.com>

